

# The Willows Concept Plan Amendment

**dream D**  
development



April 26, 2023

## **EXECUTIVE SUMMARY**

Dream Development (Dream) engaged Catterall & Wright and Carrick Design to undertake The Willows Golf & Country Club and Residential Development Concept Plan Amendment. The intent was to redesign the previously approved residential development into a premium golf course community. The golf course community will offer an unparalleled style of living with a range of housing options incorporated among a quality golf course.

When fully developed, it will be home to an additional 1,536 people and will be a fully integrated golf course community. Its physical form has been designed in a semi-circular shape, with meandering roadways to allow the landscape of the golf course to integrate among the residential development. Two new access points are proposed to the Willows community, resulting in minimal traffic impact to existing roadways.

The residential and golf course design were approached collaboratively to provide a unique development and experience for residents and golfers. The golf course has been reconfigured to improve the playability and quality, while maintaining safety setbacks from the residential development. The residential development is designed to incorporate a variety of housing options, including one-unit dwellings, low density multi-unit dwellings, and medium density multi-unit dwellings. The design also includes a proposed commercial site (Wellness Hotel/Spa) in the northern part of the community, offering complementary uses to the golf course patrons, residents, and visitors.

Open spaces are provided as part of the golf course, as well as park spaces strategically located among the residential developments. Residents will be able to enjoy these spaces through the multi-use walking trail, which will travel around and through the golf course, providing connectivity to the clubhouse.

The Concept Plan Amendment is intended to enhance the Willows Golf Course and surrounding community into a premium recreational facility and golf course community.

Additional documents supporting the Concept Plan Amendment include a Natural Area Screening, Market Studies, Hydrogeological Investigation, Sanitary Flow Monitoring Report, Public Consultation Report, and a Traffic Impact Study that are summarized in this report and detailed in the Appendices.

## NEIGHBOURHOOD QUICK FACTS (all statistics represent Concept Plan Amendment Area, unless specified otherwise)

<b>207.01 ha</b>	Total Area (includes all of The Willows)
<b>56.12 ha</b>	CPA Developable Land
<b>7.40 ha</b>	North Development Area (included in CPA Developable Land)
<b>1,536</b>	Projected Population
<b>27.38</b>	People per hectare
<b>665</b>	Total Dwelling Units
<b>25.94 ha</b>	One-Unit Dwellings
<b>9.86 ha</b>	Low Density Multi-Unit Dwellings
<b>2.35 ha</b>	Medium Density Multi-Unit Dwellings
<b>1.23 ha</b>	Commercial
<b>11.13 ha</b>	Roadways
<b>5.61 ha</b>	Municipal Reserve



# Table of Contents

- 1.0 INTRODUCTION ..... 1**
- 1.1 PURPOSE..... 1
- 1.2 GOALS & OBJECTIVES ..... 1
  
- 2.0 BACKGROUND ..... 3**
- 2.1 LOCATION & AREA..... 3
- 2.2 LAND OWNERSHIP..... 3
- 2.3 EXISTING LAND USES..... 4
- 2.4 ADJACENT LAND USES..... 4
  
- 3.0 CONCEPT PLAN AMENDMENT ..... 5**
- 3.1 DESIGN RATIONALE..... 5
- 3.2 MARKET DEMAND STUDY ..... 6
- 3.3 LAND USES..... 7
- 3.4 LAND USE STATISTICS..... 8
- 3.5 NEIGHBOURHOOD PLAN ..... 13
- 3.6 GOLF COURSE PLAN ..... 13
- 3.7 WINTER CITY STRATEGY ..... 14
  
- 4.0 REGULATORY FRAMEWORK ..... 15**
- 4.1 OFFICIAL COMMUNITY PLAN ..... 15
- 4.2 ZONING..... 20
- 4.3 AMENDMENTS ..... 20
  
- 5.0 TRANSPORTATION..... 22**
- 5.1 ROAD CLASSIFICATIONS ..... 22
- 5.2 TRAFFIC IMPACT STUDY (TIS) ..... 22
- 5.3 STREET LIGHTING ..... 23
- 5.4 ACTIVE TRANSPORTATION ..... 23

<b>6.0</b>	<b>SERVICING.....</b>	<b>26</b>
6.1	STORMWATER.....	26
6.2	WATER DISTRIBUTION.....	28
6.3	SANITARY SEWER .....	31
6.4	GEOTECHNICAL.....	34
<b>7.0</b>	<b>PUBLIC CONSULTATION .....</b>	<b>35</b>
7.1	SUMMARY OF CONSULTATION .....	35
7.2	KEY REVISIONS FROM CONSULTATION .....	35
7.3	FEE SIMPLE OWNERSHIP .....	36
<b>8.0</b>	<b>IMPLEMENTATION.....</b>	<b>37</b>
8.1	DEVELOPMENT PHASING STRATEGY.....	37

## **SUPPORTING DOCUMENTS**

APPENDIX A - TRAFFIC IMPACT STUDY

APPENDIX B - SANITARY FLOW MONITORING

APPENDIX C - NATURAL AREA SCREENING

APPENDIX D - THE WILLOWS PREMIUM HOUSING STUDY

APPENDIX E - THE WILLOWS HOTEL/SPA & RETAIL MARKET STUDY

APPENDIX F – WILLOWS PUBLIC CONSULTATIONS 2022

APPENDIX G – WILLOWS MARKET ANALYSIS (BRUNSDON LAWREK & ASSOCIATES)

APPENDIX H – HYDROGEOLOGICAL INVESTIGATION

# 1.0 INTRODUCTION

The Willows Golf & Country Club (the Willows), identified in the Location Plan in Figure 1.0, was originally planned as a standalone site for a golf course until 2004 when construction of a residential subdivision began, creating Saskatoon's first golf course community. As of 2022, the Willows is a 27-hole golf course with residential development, a clubhouse with meeting and banquet facilities, and pro shop. The Willows extends total 207.01 hectares (511.53 acres) and this Concept Plan Amendment for Phase 2 of the Willows projects the addition of 1,536 people to the community. The approved plan for Phase 2 of the Willows projected 697 people; however, the approved Phase 2 did not include development of the larger area to north that is referred to as the North Development Area in this report.

## 1.1 PURPOSE

Dream Development (Dream) is seeking approval for a Concept Plan Amendment (CPA) to the current and approved plan. Upon approval, Dream will be pursuing the development and restructuring of the golf course as outlined in the CPA. This report provides a framework for the development and reconfiguration of services including roadways, water distribution, sanitary sewer, storm water management and the open space system.

The approval of this CPA will allow Dream to proceed with the design and construction of services so the proposed phases of the Willows can be built out within the framework of this concept plan.

## 1.2 GOALS & OBJECTIVES

The Willows is a Golf Course Community that will offer a unique recreational and wellness lifestyle to its future and existing residents. The reconfiguration of the site is intended to enhance the Willows Golf Course into a premium recreation facility for Saskatoon and its visitors. The CPA aims to achieve the following objectives within its detailed golf course and community design:

- Provide a premium recreation destination for golfers in Saskatoon and surrounding communities;
- Provide diverse leisure and wellness activities for both residents and visitors;
- Increase the quality and experience for homeowners and visitors;
- Preserve and build on aesthetic value of the existing community and built environment;
- Offer a variety of housing options for future residents;
- Provide a built environment that considers non-vehicular modes of transportation within the neighbourhood; and
- Ensure public spaces within the neighbourhood are functional and inclusive to all users, including non-golfers.

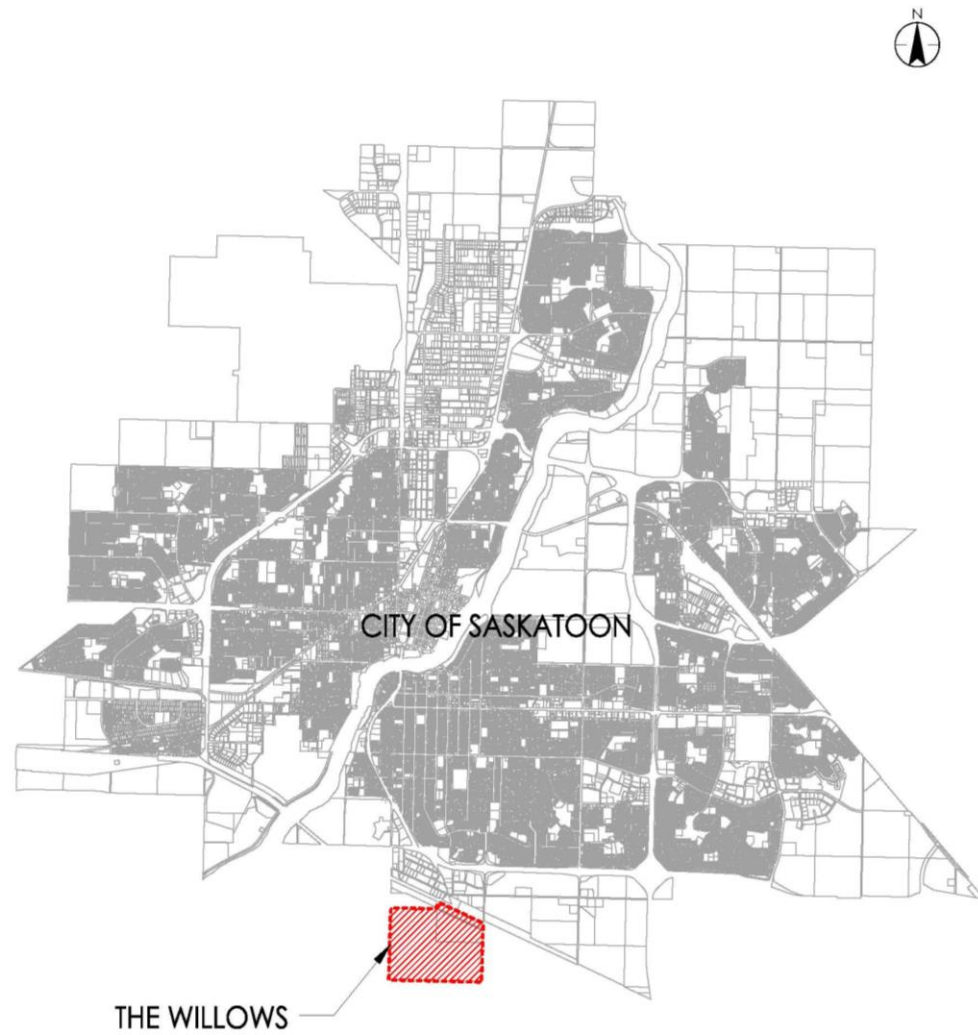

Figure 1.0 Location Plan

## 2.0 BACKGROUND

### 2.1 LOCATION & AREA

The Willows Neighbourhood is located on the southern edge of Saskatoon (refer to Figure 1.0 Location Plan). The 207.01 ha site is situated south of the CN Industrial area, east of Lorne Avenue and west of Clarence Avenue. The proposed CPA is located on the west side of the Willows. To the northeast of the site is the Stonebridge neighbourhood and shopping centre.

The CPA area is a minor deviation from the approved border between Phase 1 and Phase 2 of the Willows. One Unit Dwellings proposed in the southeast, as well as the two Municipal Reserve parcels by 401, 404, 405, and 408 Cartwright Street are currently within the original Phase 1 of the Willows.

### 2.2 LAND OWNERSHIP

The CPA area is predominantly owned by Willows Golf Incorporated. In addition to this area, the CPA area also includes a triangular shaped parcel in the north bordered by Cartwright Street. This parcel is owned by 102105352 Saskatchewan Ltd.



- The Willows Approved Phase Boundary
- Approximate Boundary Deviation (See Figure 3.0)



## 2.3 EXISTING LAND USES

The existing land use is part of the 27-hole golf course and clubhouse within the Willows Golf & Country Club. 18 of the total 27 holes are currently amongst the CPA area. Additionally, there are golf course maintenance buildings at the extreme northwest part of the area.

## 2.4 ADJACENT LAND USES

To the north of the CPA area is the South Development Area (SDA), which was annexed into the City of Saskatoon in September of 2015. This portion of the SDA includes the Schroh Arena, a community centre, and a residential acreage. Bordering the northern part of this portion of the SDA is Cartwright Street and the CN Rail line.

The CPA area is bound to the west by Lorne Avenue, with agricultural land and the organized hamlet of Furdale further west. Lands to the west of Lorne Avenue are within the Rural Municipality of Corman Park. To the east of the CPA area is the existing Willows Golf Course and residential communities (Phase 1). South of the CPA area is privately owned agricultural land. Refer to Figure 2.0 Existing Land Use.



The Willows: Concept Plan Amendment Area



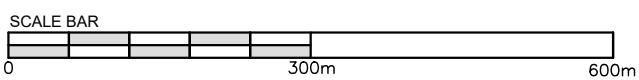
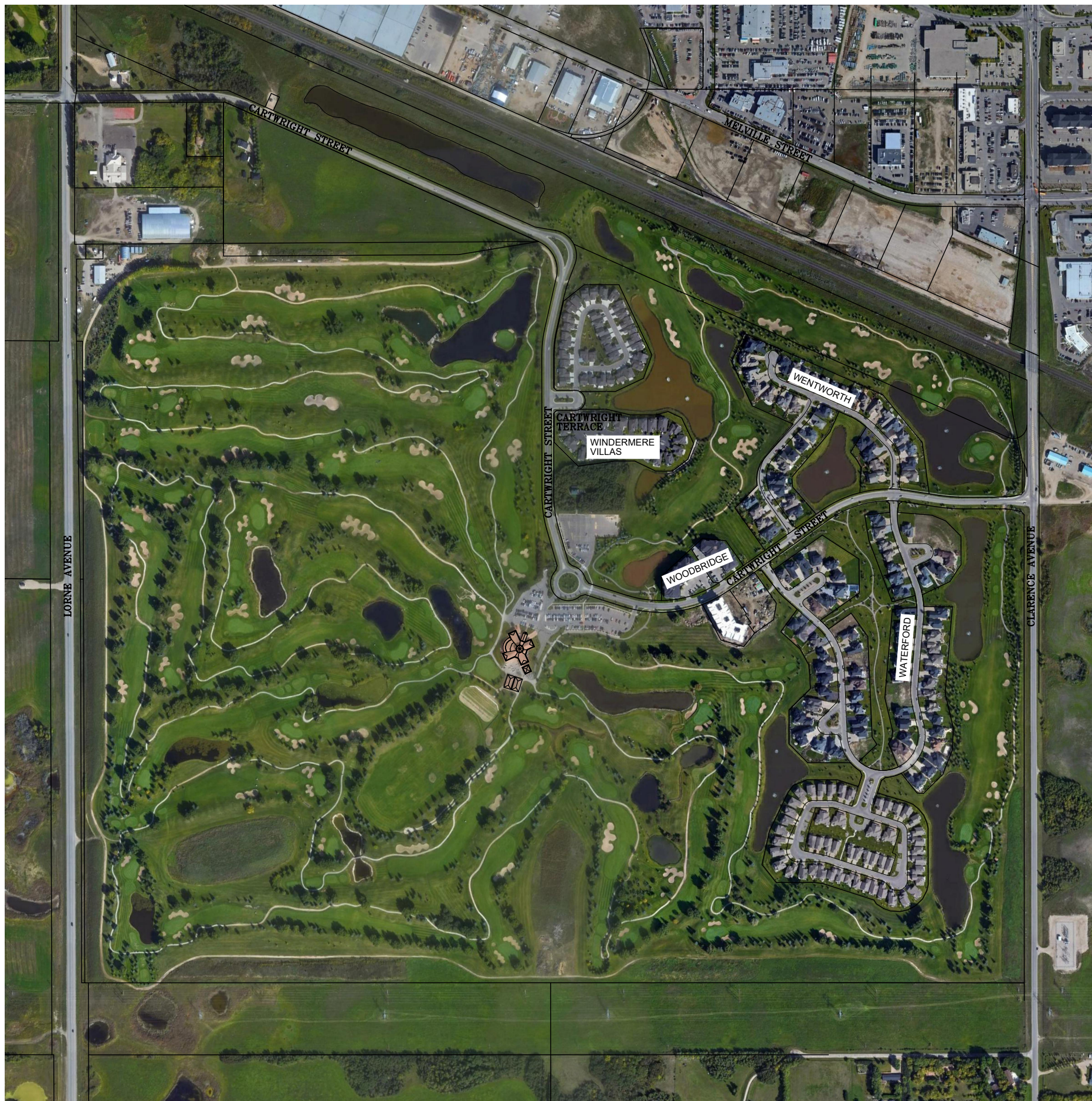
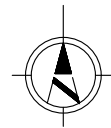

## 3.0 CONCEPT PLAN AMENDMENT

### 3.1 DESIGN RATIONALE

The CPA proposes a reconfiguration of the previously approved residential development plan with large lot and multi-family homes, and a commercial (Wellness Hotel/Spa), all of which will be carefully integrated with a premium 18-hole golf course.

*The Willows, Saskatoon Premium Housing Study* was conducted by Consumer Strategies Group for the purposes of establishing the demand for large lot style homes in Saskatoon. The study determined there is an unsatisfied demand for large lot homes. The wider and larger lots planned at the Willows will help fulfill this demand.

The design provides a complementary housing style to the unique golf course amenity it is designed within. Both the golf course and neighbourhood designs were completed simultaneously to provide a cohesive layout and high-quality plan.

Careful thought and consideration went into the design of the CPA. The goal is to retain as many existing, quality golf holes as possible and to rebuild and redesign new hole layouts to achieve a premium golf course community. The CPA was planned so that development may be phased over time and to minimize disruption to the golf course during construction periods. Many of the existing trees will remain untouched, however, the development will require that some be removed. It is estimated that approximately 740 trees require removal to accommodate the CPA. The development will see approximately 1,450 new trees planted within the new golf course layout and within residential lots. Additionally, many more will be established in landscaping/buffer strips as part of multi-family and commercial sites. Some of these sites have existing trees which builders will be encouraged to incorporate into site design.

Planning a residential development within a golf course serves as a recreational amenity for local residents and surrounding area. A golf course integrated with the development creates an attractive setting and enhanced value for homes in the area. The proximity to recreational activity and greenspace will contribute to a healthy lifestyle.

The CPA offers a similar lifestyle and housing product as the existing Willows development, with minor variations. These include:

- A commercial site (Wellness Hotel/Spa) accessible by vehicle or pedestrian connections.
- Introduction of municipal reserve spaces and playground/sporting amenities.
- Increased walking trails with a focus on connectivity.
- Further medium density development near the clubhouse which builds on the focal point of the community.

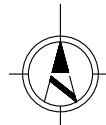

**LEGEND:**

- CONCEPT PLAN AMENDMENT AREA
- ONE UNIT DWELLINGS
- LOW DENSITY MULTIPLE UNIT DWELLINGS
- MEDIUM DENSITY MULTIPLE UNIT DWELLINGS
- LOW OR MEDIUM DENSITY MULTIPLE UNIT DWELLINGS  
(NOTE: POPULATION PROJECTION AND SERVICING STRATEGY ASSUMES THIS AREA AS MEDIUM DENSITY)
- COMMERCIAL
- MUNICIPAL RESERVE (LINEAR PARK)
- MUNICIPAL RESERVE (POCKET PARK)

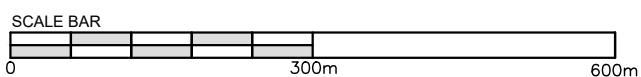

## 3.2 MARKET DEMAND STUDY

### 3.2.1 Residential Market

*The Willows, Saskatoon Premium Housing Study (Study)* by Consumer Strategies Group, conducted in 2017, reviewed the demand for large lot style homes in Saskatoon. The study reviewed the economics and housing trends of Saskatoon and Saskatchewan.

At the time the study was completed, there were four markets in Saskatoon offering large lot style homes: the Willows, Greenbryre, Rosewood and Evergreen. Rosewood and Evergreen have only remnant supply of these types of homes. Greenbryre has a larger inventory, however; absorption rates have been higher than market expectations which warrants more demand for this product.

The Study reviewed the inventory and absorption volumes of large lot style product in the four existing developments within Saskatoon. The results indicated an unsatisfied demand for large lot style product, supporting the Willows CPA.

### 3.2.2 Commercial Market

A market demand assessment was completed by Urbanics Consultants Ltd. in 2021, focusing on a Nordic Spa and Wellness Hotel, as well as retail uses. Assumptions for the hotel included 120 rooms, a spa within the hotel, a 100 seat restaurant, and 4,500 sq.ft. of meeting room space. Please note that Dream has removed retail development from the proposed CPA, therefore the following key findings only include Hotel and Nordic Spa.

#### 3.2.2.1 Hotel

- In 2018, Saskatoon captured 21% of Saskatchewan's visitors (>2.7M visits).
- In 2018, there were approximately 1,085,000 overnight visitors, 33% of which stayed in commercial accommodations.
- Of 18 Saskatoon hotels ranging in class from midscale to upscale, the average number of rooms per property is 151.
- Given the hotel's proximity to the Willows Golf Course and Clubhouse, it is anticipated that much of the demand will stem from the leisure segment.
- Local competition of similarity includes the Damara Day Spa which has two locations within the Home Inn & Suites in southern Saskatoon as well as the Delta Bessborough in downtown Saskatoon. There are currently no hotel properties with outdoor Nordic/thermal treatments in Saskatoon.
- The proposed hotel is projected to reach occupancy of 63.3% with some 27,742 occupied room nights by 2028. Typical occupancy rates for Canadian hotels across all seasons is between 50% and 80%.

### 3.2.2.2 Nordic Spa

- The global spa market is projected to grow at a rate of 5.7% during 2018 to 2023.
- The Willows is well suited to capture spa demand from surrounding residents, as well as same-day and overnight leisure-based markets in the region.
- There are few spas in Saskatchewan considered competitive to the proposed Nordic Spa – The existing Sun Tree Spa at Temple Gardens Hotel & Spa in Moose Jaw is considered the most comparable to the proposed Nordic Spa. In Canada there are only a few Nordic Spas outside of Quebec. This includes the Kananaskis Nordic Spa in Alberta which opened in 2018 and the Thermea Nordik Spa-Nature in Manitoba which opened in 2015.
- The Nordic Spa is forecasted to experience 47,000 visitors by its third year of operation, of which 52% are anticipated to be hotel guests staying overnight.

## 3.3 LAND USES

### 3.3.1 Residential

As noted in Section 3.2, there is adequate demand in Saskatoon for large lot style housing. The Willows age group demographics currently consists of all age groups; however, it is largely driven by age cohorts of 50+. To supply the market with various types and sizes of dwellings catering to varying groups, the proposed residential development includes:

- One-Unit Dwellings consisting of 25.94 ha (64.10 acres). In the DCD4 Zoning District, this is a permitted use. Table 3-3 displays the developer's estimation of 305 units at a density of 11.8 units/ha (4.8 units/acre).
- Low Density Multi-Unit Dwellings and Dwelling Groups consisting of 9.86 ha (24.36 acres). In the DCD4 Zoning District, this is proposed as a permitted use that will facilitate a density of up to 12 units/acre (in the existing DCD4, the density is set higher at up to 17 units/acre). Table 3-3 displays the developer's estimation that this land use will produce 177 units at a density of 18.0 units/ha (7.3 units/acre). This land use may include one-unit, semi-detached, townhouse, and multiple-unit dwellings as part of a dwelling group.
- Medium Density Multi-Unit Dwellings and Dwelling Groups consisting of 2.35 ha (5.81 acres). In the DCD4 Zoning District, this is a permitted use that facilitates a density of up to 50 units/acre. Table 3-3 displays the developer's estimation that this land use will produce 183 units at a density of 77.8 units/ha (31.5 units/acre). This land use may include semi-detached, townhouse, multiple-unit dwellings and dwelling groups.

### 3.3.2 Commercial (Hotel/Spa)

On the west side of the North Development Area and bordering the Schroh Arena is a 1.23 ha (3.04 acre) proposed commercial site. The vision of this future commercial site is for a Wellness Hotel and Nordic Spa. Other commercial uses may include only those accessory to a hotel, such as retail, restaurant, lounge, pools, meeting and banquet facility, and other accessory uses permitted in the DCD4 zoning district.

For context, there are several examples in Canada of which golf course communities are integrated with hotel accommodations and associated amenities. Some of these examples include:

**Bear Mountain Resort Community, Victoria, BC** includes a mix of residential development densities, hotels, spa, and various other commercial amenities.

**Predator Ridge, Vernon, BC** includes low density residential, hotel, and various other commercial amenities.

**Cobble Beach, Owen Sound, ON** includes low density residential, hotel, and spa.

**Crown Isle, Comox Valley, BC** includes a mix of residential development densities, hotel, and various other commercial amenities.

**Fairmont Springs Resort, Fairmont, BC** includes a mix of residential development densities, hotels and villa rentals, and various other commercial amenities.

## 3.4 LAND USE STATISTICS

Land uses for the existing Willows and proposed development are displayed in the tables below, as per the following:

- Existing Willows (Phase 1) – Table 3-1
- Existing Willows (Phase 1) combined with original proposed Willows (Phase 2) – Table 3-2
- Existing Willows (Phase 1) combined with current proposed Willows CPA (Phase 2) – Table 3-3

Table 3-1 Existing Willows Ph.1

The Willows Land Use Statistics - Existing Ph.1							
Land Use	Hectares	Acres	%	Units/Ha	Units	People/Unit	Population
<b>Willow Glen - 201 Cartwright</b>							
One-Unit Dwellings	2.02	4.99	0.98%	17.82	36	2.8	100.8
Roadways	0.37	0.91	0.18%				
<b>Total</b>	<b>2.39</b>	<b>5.91</b>	<b>1.15%</b>		<b>36</b>		<b>100.8</b>
<b>Windermere Villas - 301 Cartwright</b>							
One-Unit Dwellings	1.64	4.05	0.79%	17.68	11	2.8	30.8
Low Density Multi-Unit Dwellings (Group)					18	2.2	40
Roadways	0.31	0.77	0.15%				
<b>Total</b>	<b>1.95</b>	<b>4.82</b>	<b>0.94%</b>		<b>29</b>		<b>70</b>
<b>The Woodbridge - 401 &amp; 405 Cartwright</b>							
<b>Medium Density Multi-Unit Dwellings</b>	<b>0.88</b>	<b>2.17</b>	<b>0.43%</b>	<b>73.86</b>	<b>65</b>	<b>1.6</b>	<b>104</b>
<b>404 Cartwright</b>							
<b>Medium Density Multi-Unit Dwellings</b>	<b>0.47</b>	<b>1.17</b>	<b>0.23%</b>	<b>82.45</b>	<b>39</b>	<b>1.6</b>	<b>62</b>
<b>408 Cartwright</b>							
<b>Medium Density Multi-Unit Dwellings</b>	<b>0.43</b>	<b>1.07</b>	<b>0.21%</b>	<b>73.90</b>	<b>32</b>	<b>1.6</b>	<b>51</b>
<b>Wentworth - 501 Cartwright</b>							
One-Unit Dwellings	4.42	10.92	2.14%	9.28	41	2.8	114.8
Roadways	0.76	1.88	0.37%				
Pond 2 (Residential Pond)	1.20	2.97	0.58%				
<b>Total</b>	<b>6.38</b>	<b>15.77</b>	<b>3.08%</b>		<b>41</b>		<b>114.8</b>
<b>Waterford - 602 Cartwright</b>							
One-Unit Dwellings	11.34	28.02	5.48%	11.38	121	2.8	338.8
Low Density Multi-Unit Dwellings (Group)					8	2.2	18
Roadways	2.70	6.68	1.30%				
Open Space (Waterford Park)	2.33	5.76	1.13%				
<b>Total</b>	<b>16.37</b>	<b>40.45</b>	<b>7.91%</b>		<b>129</b>		<b>356</b>
<b>Roadways</b>							
<b>Cartwright St (from Clarence Ave to bend north of Willow Glen)</b>	<b>3.34</b>	<b>8.25</b>	<b>1.61%</b>				
<b>North Development Area</b>	<b>6.40</b>	<b>15.81</b>	<b>3.09%</b>				
<b>Golf Course (including holes, ponds, driving range, and clubhouse)</b>	<b>168.39</b>	<b>416.09</b>	<b>81.34%</b>				
<b>TOTAL</b>	<b>207.01</b>	<b>511.52</b>	<b>100.00%</b>		<b>371</b>		<b>860</b>



Table 3-2 Existing Willows Ph.1 and Original Proposed Ph. 2

The Willows Land Use Statistics - Original Ph.2							
Land Use	Hectares	Acres	%	Units/Ha	Units	People/Unit	Population
<b>EXISTING DEVELOPMENT (PH 1)</b>							
<b>One-Unit Dwellings</b>	19.42	47.99	9.38%	12.10	209	2.8	585
<b>Low Density Multi-Unit Dwellings (Group)</b>					26	2.2	57
<b>Medium Density Multi-Unit Dwellings</b>	1.79	4.41	0.86%	76.15	136	1.6	218
<b>Residential Pond</b>	1.20	2.97	0.58%				
<b>Open Space (Waterford Park)</b>	2.33	5.76	1.13%				
<b>Local Roadways</b>	4.14	10.23	2.00%				
<b>Roadways (Cartwright St from Clarence Ave to bend north of Willow Glen)</b>	3.34	8.25	1.61%				
<b>Total</b>	<b>32.22</b>	<b>79.61</b>	<b>15.56%</b>		<b>371</b>		<b>860</b>
<b>ORIGINAL PHASE 2 DESIGN</b>							
<b>Residential</b>							
One-Unit Dwellings	10.45	25.82	5.05%	12	125	2.8	351
Low Density Multi-Unit Dwellings (Townhouse)	6.29	15.54	3.04%	25	157	2.2	346
<b>Total Residential</b>	<b>16.74</b>	<b>41.37</b>	<b>8.09%</b>		<b>283</b>		<b>697</b>
<b>North Development Area</b>	<b>6.40</b>	<b>15.81</b>	<b>3.09%</b>				
<b>Roadways</b>	<b>2.86</b>	<b>7.07</b>	<b>1.38%</b>				
<b>Golf Amenities</b>							
Course (including holes, ponds, and clubhouse)	144.52	357.12	69.81%				
Driving Range	2.54	6.28	1.23%				
<b>Total Golf Amenities</b>	<b>147.06</b>	<b>363.39</b>	<b>71.04%</b>				
<b>Open Space</b>	<b>1.14</b>	<b>2.82</b>	<b>0.55%</b>				
<b>Pond within Residential</b>	<b>0.59</b>	<b>1.46</b>	<b>0.29%</b>				
<b>TOTAL (ALL WILLOWS)</b>	<b>207.01</b>	<b>511.52</b>	<b>100.00%</b>		<b>654</b>		<b>1557</b>

Table 3-3 Existing Willows Ph.1 and Proposed CPA Ph. 2

The Willows Land Use Statistics - Proposed Ph. 2								
Land Use	Hectares	Acres	%	Frontage (m)	Units/Ha	Units	People/Unit	Population
<b>EXISTING DEVELOPMENT (PH 1)</b>								
<b>One-Unit Dwellings</b>	19.42	47.99	9.38%		12.10	209	2.8	585
<b>Low Density Multi-Unit Dwellings (Group)</b>						26	2.2	57
<b>Medium Density Multi-Unit Dwellings</b>	1.79	4.41	0.86%		76.15	136	1.6	218
<b>Residential Pond</b>	1.20	2.97	0.58%					
<b>Open Space (Waterford Park)</b>	2.33	5.77	1.13%					
<b>Local Roadways</b>	4.14	10.23	2.00%					
<b>Roadways (Cartwright St)</b>	3.35	8.28	1.62%					
<b>Total</b>	<b>32.23</b>	<b>79.65</b>	<b>15.57%</b>			<b>371</b>		<b>860</b>
<b>PROPOSED PHASE 2 DESIGN</b>								
<b>Residential</b>								
One-Unit Dwellings	25.94	64.10	12.53%	4869	11.8	305	2.8	853
Low Density Multiple Unit Dwellings	9.86	24.36	4.76%	852	18.0	177	2.2	390
Medium Density Multiple Unit Dwellings	2.35	5.81	1.14%	181	77.8	183	1.6	293
<b>Total Residential</b>	<b>38.15</b>	<b>94.27</b>	<b>18.43%</b>			<b>665</b>		<b>1536</b>
<b>Commercial</b>	<b>1.23</b>	<b>3.04</b>	<b>0.59%</b>	<b>32</b>				
<b>Roadways</b>	<b>11.13</b>	<b>27.50</b>	<b>5.38%</b>					
<b>Municipal Reserve</b>	<b>5.61</b>	<b>13.86</b>	<b>2.71%</b>					
<b>Golf Amenities</b>								
Course (includes all holes and ponds)	115.10	284.41	55.60%					
Driving Range	3.56	8.80	1.72%					
<b>Total Golf Amenities</b>	<b>118.66</b>	<b>293.21</b>	<b>57.32%</b>					
<b>TOTAL (ALL WILLOWS)</b>	<b>207.01</b>	<b>511.53</b>	<b>100.00%</b>			<b>1036</b>		<b>2396</b>
<b>MR CALCULATION</b>								
Developable Land	56.12	138.67						
MR Required @ 10%	5.61	13.87						
* Total (ALL WILLOWS) area includes P20 and P5								
*Frontages displayed are civic								

### 3.4.1 Neighbourhood Parks

Neighbourhood parks have been incorporated into the plan and will include play structures where appropriate to provide recreational opportunities for children. The parks will be integrated within the residential development and will be supplemented by a multi-use pathway system, accessed at numerous points throughout the neighbourhood. Five linear parks and two pocket parks in the CPA area represent 5.61 ha (13.87 acres) of Municipal Reserve. Additionally, the Willows has an abundance of non-designated open space including a perimeter walking path and the golf course.

**MR1** is a proposed 0.26 ha pocket park and can facilitate a play structure, passive recreation, and aesthetic appeal.

**MR2** is a proposed 0.95 ha linear park that can accommodate passive recreation and aesthetic appeal. This park will not have a perimeter walking path due to site constraints but does have the potential for lookout / seating areas.

**MR3a** is a proposed 0.25 ha pocket park and can facilitate a play structure, passive recreation, and aesthetic appeal.

**MR3b** is a proposed 0.72 ha linear park that has been sized for a half sports field. This space is also situated well for passive recreation and aesthetic appeal.

**MR4** is a proposed 1.68 ha linear park, which will provide recreational and non-recreational walking, running, bicycling, cross country skiing and wheelchair travel. This park is also ideal for people to enjoy natural features and for sitting/picnicking.

**MR5** is a proposed 1.27 ha linear park that will provide recreational and non-recreational walking, running, bicycling, cross country skiing and wheelchair travel. This park is also ideal for people to enjoy natural features, sitting/picnicking, and the potential for a community garden. This park is an existing green space within Phase 1 of the Willows, and is currently maintained by Willows Golf Inc.

**MR6** is a 0.48 ha linear park that will provide recreational and non-recreational walking, running, bicycling, cross country skiing and wheelchair travel. This park is also ideal for people to enjoy natural features, sitting/picnicking, and the potential for a community garden. This park is an existing green space within Phase 1 of the Willows, and is currently maintained by Willows Golf Inc.

The neighbourhood is connected by sidewalks/pathways to other parts of the city via:

- The sidewalk from the east end of Cartwright Street connecting to the sidewalk on the west side of Clarence Avenue
- The proposed pathway on the north side of Cartwright Street connecting to Lorne Avenue

All parks and pathways will be designed and constructed to City of Saskatoon Standards.

## 3.5 NEIGHBOURHOOD PLAN

The goal of the CPA is to create a vibrant golf course community which caters to a wider demographic and meets the objectives of the City of Saskatoon's Official Community Plan. The Willows will be developed over four subphases. Every subphase of The Willows will offer attractive views of the golf course and/or developed landscapes. Residences will be within walking distance of the clubhouse and connected to the outdoor multi-use pathways and trails, ensuring accessibility throughout the neighbourhood. This will encourage residents to take full advantage of the recreational amenities just outside their front door. The land uses as shown in Figure 3.0 Concept Plan Amendment detail the neighbourhood layout.

### 3.5.1 North Development Area

Backing the Willows Golf Course to the south, this 7.40 ha development site is best suited for both low and medium density multi-family development. Additionally, through consultation with the Willows residents it was determined that the North Development Area was the more desirable location for the Wellness Hotel and Spa. Access to this development area will be conveniently located on Cartwright Street. The North Development Area is connected to the other areas of the Willows via Cartwright Street, multi-use pathways, and sidewalks throughout the development. This will keep the area well connected and integrated into the community.

## 3.6 GOLF COURSE PLAN

### 3.6.1 Golf Course Design

The Willows Golf & Country Club will be redesigned to a premium 18-hole golf course to accommodate the future residential development planned for the southern and western portions of the property. The goal for the redesign of the golf course is to improve the quality and playability of the golf course and to create a premier experience for patrons. This will be accomplished by making significant improvements to the infrastructure found on the older parts of the golf course and by elevating the overall experience with improved playability, aesthetic character, golf course features and golf course conditioning.

The new 18-hole layout for the golf course retains the first eight holes of the original course. The remaining 10 holes require varying degrees of re-alignment and re-construction in order to accommodate the adjacent residential development and to make improvements to aging course infrastructure including greens, tees, fairways, bunkers, turf quality, cart paths, drainage, and irrigation. These 10 holes have been designed/re-aligned to provide adequate setbacks to the adjacent residential development to ensure safety and privacy for existing and future residents.

The golf course was designed considering the safety of the residents and their homes by offsetting the golf holes from the rear lots a considerable distance while also retaining as many mounds and trees as possible along the hole boundaries for further protection. While safety was one of the leading priorities in the design of the golf course, other items considered include playability of the course for all skill levels, water conservation, incorporating naturalized areas, speed of play and walkability of the course.

The design of the neighbourhood and golf course were done in conjunction with each other to achieve a cohesive and high-quality golf course community.

### 3.7 WINTER CITY STRATEGY

The WintercityYXE Vision states “Saskatoon is a vibrant, prosperous and dynamic community that thrives during winter months and works together to support an active winter lifestyle that is inclusive and accessible for all.”

The Willows CPA facilitates recreational activity and includes six park spaces presenting many opportunities for all-season activities. The developer is committed to working with the City of Saskatoon on exploring winter city strategies. Activities may include cross-country skiing and skating, with many other opportunities to be explored. The Willows CPA seeks to provide diverse leisure activities for both residents and visitors.

Notable sections from the Winter City YXE Implementation Plan include Action 7 – “Support a variety of existing and new winter activities and events for all ages and abilities including the development of new ideas and concepts”, and Action 24 - “Support the development of winter amenities and facilities”. The Willows CPA proposes a Nordic Spa which is a new winter activity for Saskatoon residents and visitors. Market studies have shown that Nordic Spa’s are busiest during shoulder seasons and the winter months. This will keep people active during the colder months, creating vibrancy and promoting wellness at a time when it is most needed.

## 4.0 REGULATORY FRAMEWORK

### 4.1 OFFICIAL COMMUNITY PLAN

The City of Saskatoon’s Official Community Plan (OCP) Bylaw No. 9700 provides the policy framework to define, direct, and evaluate development in the City of Saskatoon, ensuring that development takes place in an orderly and rational manner, balancing the environmental, social, and economic needs of the community. Section G3.2 in the OCP provides objectives and policies for Golf Course Communities. The objective within this section of the OCP states “Facilitate the development of Golf Course Communities in Saskatoon to allow for a greater range of housing options and lifestyle choices.”

Policies within Section G3.2 of the OCP are displayed below, along with comments on how the CPA conforms to each policy.

Policy	CPA Conformity
<b>G3.2(2)(a) Each Golf Course Community must include an active golf course maintained for private or public use.</b>	<i>The Willows Golf Course is currently a 27-hole course. The Willows will permanently transition to an 18-hole course during construction of the CPA area.</i>
<b>G3.2(2)(b) Each golf course community should be individually designed for local conditions. Individual project design, land use, phasing and related servicing will be approved through a Direct Control District. For each development application, a market demand study and market projection must be submitted to and accepted by Administration.</b>	<i>The market demand/projection studies have been provided, as required, and can be found in Section 3.2.</i>
<b>G3.2(2)(c) Golf course communities typically have a low gross per acre density. As such, they will not be expected to align with required densities referenced in the Plan.</b>	<i>The CPA is projected to achieve a density of 11.85 units per gross developable hectare, as opposed to standard neighbourhoods which are expected to achieve a minimum of 17.3 units per gross developable area. Area of calculation does not include golf course.</i>

<p><b>G3.2(2)(d) Golf Course Communities may include low to medium density residential development and a mix of commercial development regularly associated with, and of a scale appropriate to, the daily operations of a golf course and the daily needs of golf course community residents.</b></p>	<p><i>The CPA includes primarily low density residential with a small amount of medium density residential, as defined within the DCD4 Regulations. A Wellness Hotel/Spa is also proposed and will increase amenity and broaden the Willows appeal as a year-round wellness destination. The inclusion of the Wellness Hotel/Spa requires an OCP amendment to revise allowable land uses (see Section 4.3).</i></p>
<p><b>G3.2(2)(e) Typical residential services such as internal water and sewer, roadways, garbage collection, street cleaning, snow removal, transit, and maintenance of parks and open space, will be the responsibility of: (i) a Bareland Condominium Association or Homeowners’ Association; (ii) the City, depending on the specific design characteristics, potential financial implications, and service impacts of the development; or (iii) any combination thereof.</b></p>	<p><i>The CPA area will be designed as fee simple (for one-unit dwellings) and therefore the City will be responsible for all typical residential services within the CPA area except transit which is not a service currently provided to the Willows.</i></p>

Other applicable sections of the OCP include the following:

Policy	CPA Conformity
<p><b>D1.1(2)(b) - Support efforts to achieve wellbeing in all dimensions of health, including physical activity, and mental and emotional wellness.</b></p>	<p><i>The CPA proposes several features that promote wellbeing. These include:</i></p> <p><b>Physical Activity</b> – <i>The CPA includes six new park spaces, all of which will encourage physical activity. See Section 3.3.5 of the CPA. A perimeter walking path exists and will remain. This pathway facilitates long nature walks or off-road cycling in the summer, as well as cross country skiing or snow shoeing in the winter. The new sidewalks and multi-use pathways allow for excellent pedestrian connectivity which promotes walking/cycling loops or for accessing the clubhouse for its existing and future amenities.</i></p> <p><b>Mental and Emotional Wellness</b> – <i>The above notes on Physical Activity provide increased opportunities for existing and future residents of the Willows to participate in physical activity and social interaction, and provide access to natural areas (parks and perimeter pathway). As noted in Section D1.1 – Health and Wellbeing, the aforementioned design considerations “help reduce stress, while promoting health and wellbeing for all residents”.</i></p>
<p><b>D3.1(2)(c) - Support efforts to elevate Saskatoon’s creative cultural economy and tourism profile.</b></p>	<p><i>The CPA proposes a commercial site which includes a Wellness Hotel and Spa. This new land use shifts the Willows from a golf course community to a golf course community with a resort component. The resort component will benefit Saskatoon’s tourism profile.</i></p>



<p><b>G1.3(2)(e) Promote the intensification of developed urban areas to minimize the urban footprint and accommodate long-term regional growth.</b></p>	<p><i>Proposing to intensify existing neighbourhood concept plans should be well defined, clear, and articulated, providing existing residents assurances of what will be constructed. The CPA is defined, clear, and articulate. Furthermore, all development proposed within the CPA will be regulated by the DCD4 zoning district. This highly specific zoning district protects the community from other uses being built on the site in the future due to its specificity with uses and development standards, unless a proposal is put forward and accepted by the City to amend the bylaw. By amending DCD4 to allow for the uses contained in this proposal, the community will be able to grow through intensification but in a compatible and controlled manner.</i></p>
<p><b>D7(2)(c) - Celebrate Saskatoon as a four season city, inviting and vibrant even in the coldest months, through the creation of versatile multi-season public spaces.</b></p>	<p><i>The CPA expands the Willows and the City of Saskatoon’s ability to be inviting and vibrant year-round. The Willows CPA Winter City Strategy is contained in Section 3.7.</i></p> <p><i>Creating walkable amenities in the community facilitates active lifestyles, even in the coldest months. The proposed commercial site (Wellness Hotel/Spa) will bring people to the community where amenities and activities can be explored during all seasons.</i></p> <p><i>The open spaces, sidewalks, pathways, and amenities within the Willows all contribute to an inviting and vibrant environment. By providing for a hotel in the Willows, visitors to Saskatoon can utilize accommodations while being able to enjoy all features of the community in any season.</i></p>

<p><b>F2.2(29) - Land designated as “Direct Control District” has the potential for varied land uses, densities and intensities of development, as established by a Direct Control District within the Zoning Bylaw.</b></p>	<p><i>The CPA acknowledges the existing DCD4 in the context of revising the Willows Phase 2 Concept Plan. Most importantly, recognizing that DCD zoning districts have the ability to control land uses, densities, and intensities of development. For the introduction of the commercial site (Hotel/Spa), the CPA includes a very specific set of permitted uses. By way of limited parcel availability and limited types of uses, the City of Saskatoon and existing Willows residents are provided assurances of the future of the community.</i></p>
<p><b>I1.3(2)(a) - Support commercial tourism and related development throughout the region, including opportunities for regional recreation, and working with First Nations and Métis communities.</b></p>	<p><i>The Wellness Hotel/Spa will create significant tourism activity for the City of Saskatoon. The market study has indicated that the hotel will see 27,742 occupied room nights by 2028, and the spa is forecasted to experience 47,000 visitors by its third year of operation.</i></p>

## 4.2 ZONING

The subject lands are currently zoned DCD4 (Direct Control District). The objectives of this district are to facilitate a unique category of residential development integrated into the Willows community. The CPA generally meets the purpose and objectives of DCD4, however some amendments are required. These amendments are described in the following section.

## 4.3 AMENDMENTS

The Willows was originally a 36-hole golf course and operated as such for many years. In 2004, construction of a residential development began, creating Saskatoon's first golf course community. As the first golf course community in Saskatoon, special objectives and policies were created to manage and control development; a new zoning category was created (DCD4) and the previous Official Community Plan Bylaw No. 8769 included a section dedicated to Golf Course Communities (Section 5.6).

An amendment to the Zoning Bylaw is requested to reduce minimum lot parameters. At the time the Willows was first developed, the average lot width was larger than it currently is now. Amendments to the existing DCD4 zoning district are proposed for this development area to update parameters to align them with current market preferences and practices. A decrease in the minimum lot parameters for one-unit dwellings (from 18 m to 16 m) would adhere to current practice. It is proposed the DCD4 amendment include the option for fee simple lots within the CPA area (see Figure 3.0). Development standards, including landscaping requirements, shall be developed for a hotel site. It is also proposed that the maximum density of low density multiple-unit dwellings and dwelling groups be lowered from 17 dwelling units per acre to 12 dwelling units per acre.

The existing Saskatoon Zoning Bylaw map detailing the original Concept Plan will require amendment in accordance with the proposed neighbourhood design, including a change to the phasing boundary. Once the CPA is approved, the above details regarding requirements in the district will take place in the form of an OCP and zoning amendment before the legal subdivision is approved.

Proposed amendment to the OCP:

- Section G3.2(2)(d) requires an update to allow for the addition of new land uses including a hotel and spa.
- OCP Land Use Map requires an update from 'Under the control of the Corman Park – Saskatoon Planning District' to 'Direct Control District'.

Proposed amendments to the Zoning Bylaw:

- The inclusion of a Commercial development zone, including the provision for a hotel and spa and required landscaping/buffering.
- Reduction of the minimum site width to 16.0 m for one-unit dwellings.
- Reduction of the minimum site area (m<sup>2</sup>) = 560.0 for one-unit dwellings.

- The inclusion of fee simple lots.
- The inclusion of the North Development Area on the DCD4 Map.
- Adjustment of the Phase 1 / Phase 2 Boundary on the DCD4 Map.
- The inclusion of developments standards for a hotel and accessory uses.
- Additional landscaping requirements.
- Reduction of the maximum density for low density multiple-unit dwellings and dwellings groups to 12 units per acre.

## 5.0 TRANSPORTATION

The Willows community is bound by Lorne Avenue to the west, Clarence Avenue to the east, and Canadian National Railway (CNR) to the north. The Willows will be accessed by a public collector from Cartwright Terrace in the north, a new access from Lorne Avenue from the northwest, and a new access from Clarence Avenue in the southeast. All roadways within the Willows are proposed to be public facilities and will be designed to existing City of Saskatoon standards.

### 5.1 ROAD CLASSIFICATIONS

Recommended classifications for the study are roadways were determined based on the City of Saskatoon New Neighbourhood Design and Development Standards Manual, Section Eight (Transportation). The recommendations are based mainly on Annual Average Daily Traffic (AADT), but also took into consideration the roadway's purpose and level of access. Roadway classifications were determined for the proposed internal roadways and are illustrated in Figure 4.0 Roadway Classifications. Figure 4.0 also identifies existing and proposed golf cart and road crossings. Road cross sections are illustrated in Figure 4.1.

### 5.2 TRAFFIC IMPACT STUDY (TIS)

The Willows TIS assessed the impacts of the development on the adjacent system and determined the layout of the internal roadway network. Details of the analysis and results can be found within the TIS, attached in Appendix A. The background traffic calculations for the development included projections from the Ministry of Highways & Infrastructure (MOHI) and Saskatoon's Growth Plan.

Trip generation, distribution, and assignment were performed to determine the traffic volumes that will be generated by the development. The generated volumes combined with background volumes provide the total traffic volumes the area is expected to experience at full build-out. These traffic volumes were analyzed using Synchro and SimTraffic to ensure the road network would operate acceptably under full build-out conditions.

The analysis determined that the internal intersections will be able to handle the future combined traffic scenario. The intersections of Lorne Avenue & Cartwright Street and Clarence Avenue & Cartwright Street will require traffic signals to maintain an acceptable level of service. The TIS recommended intersection lighting and an intersection of Lorne Ave and Access A providing for all traffic movements; A speed reduction from 80 km/hr to 60 km/hr was also recommended along Highway 219 adjacent the new development. The TIS also recommended a future intersection providing access to the development via Access D and Clarence Avenue. Further details are provided in the appended Traffic Impact Study. Necessary MOHI approvals are provided via separate attachments (emailed to City Administration).

## 5.3 STREET LIGHTING

All street lights will be designed in accordance with City of Saskatoon and Saskatoon Light & Power Standards.

## 5.4 ACTIVE TRANSPORTATION

### 5.4.1 Transportation Overview

Currently, there is a single separated sidewalk along Cartwright Street on one side from Clarence Avenue to Cartwright Terrace. This separated sidewalk starts at Clarence Avenue on the north side of Cartwright Street, crosses south at the intersection with Waterford and Wentworth roads, then connects with the Clubhouse before it crosses the street again near The Red Barn and connects to Cartwright Terrace. This sidewalk connects with the combined sidewalk which is located along the west side of Clarence Avenue and travels north to Stonebridge Boulevard / Melville Street. As well, an internal walking path is located within the greenspace of the Waterford Community.

Access Road A is classified as a collector residential roadway with a 21.0m right-of-way with no parking, vertical curb, a separate sidewalk, and a multi-use pathway (Collector Residential B Typical Section). Access Road B is classified as a collector residential roadway with a 22.5m right-of-way with parking and sidewalks on both sides of the roadway (Collector Residential A Typical Section). Access Road D is classified as a collector residential roadway with a 22.5m right-of-way without parking, curbs, and sidewalks (Collector Residential C Typical Section). Note that no sidewalks are recommended in the cross section because there is no pedestrian connection available at the intersection of Access Road D and Clarence Avenue South. However, a multi-use path has been proposed in the cross section within the Willows Golf Course lands. All other cul-de-sacs and crescents within the Willows will be classified as either local residential A or B roadways with parking, rolled curbs, and sidewalks on both sides.

Connections to the active transportation network outside of the proposed development will be provided along Clarence Avenue and Lorne Avenue. There is an existing sidewalk along the west side of Clarence Avenue which provides connectivity to the mixed-use developments to the north. Also included in the development is a proposed pathway along the north side of Cartwright Street and the east side of Lorne Avenue which will connect to the existing pathway network along Lorne Avenue at Melville Street.

### 5.4.2 Pedestrian Walkability

The CPA layout has been mindfully designed to ensure each residence within the development will be located within reasonable walking distance to the clubhouse. Where roadways and key pedestrian corridors intersect, the crossing design will be given special attention to ensure safety and efficient movement of pedestrians and cyclists. Crossings are identified in Figure 5.0 Parks and Pedestrian Linkages.

The golf course landscape will include an expansive multi-use pathway (owned and maintained by Willows Golf Inc) shared by all users that will further encourage pedestrian walkability and offer varying options for walking and cycling routes around the neighbourhood as displayed in Figure 5.0 Parks and Pedestrian Linkages. The trail will provide pedestrian connectivity throughout the neighbourhood and encourage movement to and from the clubhouse area. Connections will be barrier free within the site and clearly marked. Local sidewalks throughout the neighbourhood will supplement the pedestrian linkages throughout the parks and golf course, making a complete pedestrian network throughout the entire development. The pathway will connect to the existing development via sidewalks along Cartwright Street, which connects to the existing path system in the greenspace in the Waterford development and it will also connect to the east corner of the North Development Area and at Access A on Lorne Avenue.

As the pathway is part of a golf course community, it will be signed throughout for safety purposes. To ensure safety of pedestrians, pathway locations will be further reviewed during detailed design and safety measures put in place where required. The pathway will offer an amenity to the residents and non-golfers who want to take advantage of where they live and have an active lifestyle.

Multi-use pathways in parks will be designed as 3.0 m pathways which allows for both pedestrian and cyclist movement. Roadways within the development will have shared facilities within the standard cross sections.

The CPA also includes proposed sidewalk and crosswalk additions on existing Cartwright Street. The following list includes recommendations from the City of Saskatoon 2021 Willows Neighbourhood Traffic Review, and recommendations by Dream. Dream will work with the City on any particulars or adjustments to the below list.

- Separated sidewalk on the west side of Cartwright Street, between the traffic circle adjacent to the clubhouse and where Cartwright Street turns to the west.
- Separated sidewalk on the north side of Cartwright Street, between the traffic circle and 501 Cartwright Street.
- Separated sidewalk on the east/north side of Cartwright Street, from Cartwright Terrace to Lorne Avenue. Please note this sidewalk will convert to a multi-use pathway where Cartwright Street turns west, as displayed on Figure 5.0.
- Standard crosswalk on west side of Cartwright Street at 501 Cartwright Street.
- Standard crosswalk between proposed Block 14 and the west entrance to the Red Barn parking lot.
- Standard crosswalk on south side of Cartwright Street at Cartwright Terrace.
- Standard crosswalk on Cartwright Street, approximately 80 m west (exact location to be determined in coordination with City of Saskatoon) of where Cartwright Street turns west (adjacent to Block 16).

Please note all proposed sidewalks and crosswalks are displayed on Figure 5.0 Parks and Pedestrian Linkages.

### 5.4.3 Traffic Calming

Through extensive conversations with the Willows residents, it was determined that traffic calming was desired on Cartwright Street under existing conditions. As a result, the CPA includes the following traffic calming measures on Cartwright Street. Please note these are subject to change based on City review.

- Speed cushion on Cartwright Street in between Waterford Park and Pond #17.
- Speed cushion between proposed Block 15 and the Red Barn.

The speed cushion locations were selected based on the following criteria:

- A minimum of 75 m from intersections.
- Not directly adjacent to single family residential.
- In 'straight-away' areas of roadway where speeding is most likely to occur.

Speed Cushions are one of the vertical deflection traffic calming measures recommended by TAC (Transportation Association of Canada), in their Canadian Guide to Traffic Calming (Second Edition, 2018). As stated by the TAC, a speed cushion is a segmented speed hump which allows for the normal passage of emergency vehicles or buses while still reducing passenger vehicle speeds. The width of the speed cushion is designed to allow emergency and bus traffic to straddle the cushion with minimal disturbance and reduction of speed. By implementation of the speed cushion, vehicle speed and volume have seen reductions up to 8 km/hr and 30%, respectively. Neighbourhood local and collector roadways are applicable road classifications that permit the installation of a speed cushion. In addition to the installation of the speed cushion itself, appropriate signage such as the WA-50 Speed Hump sign is recommended.



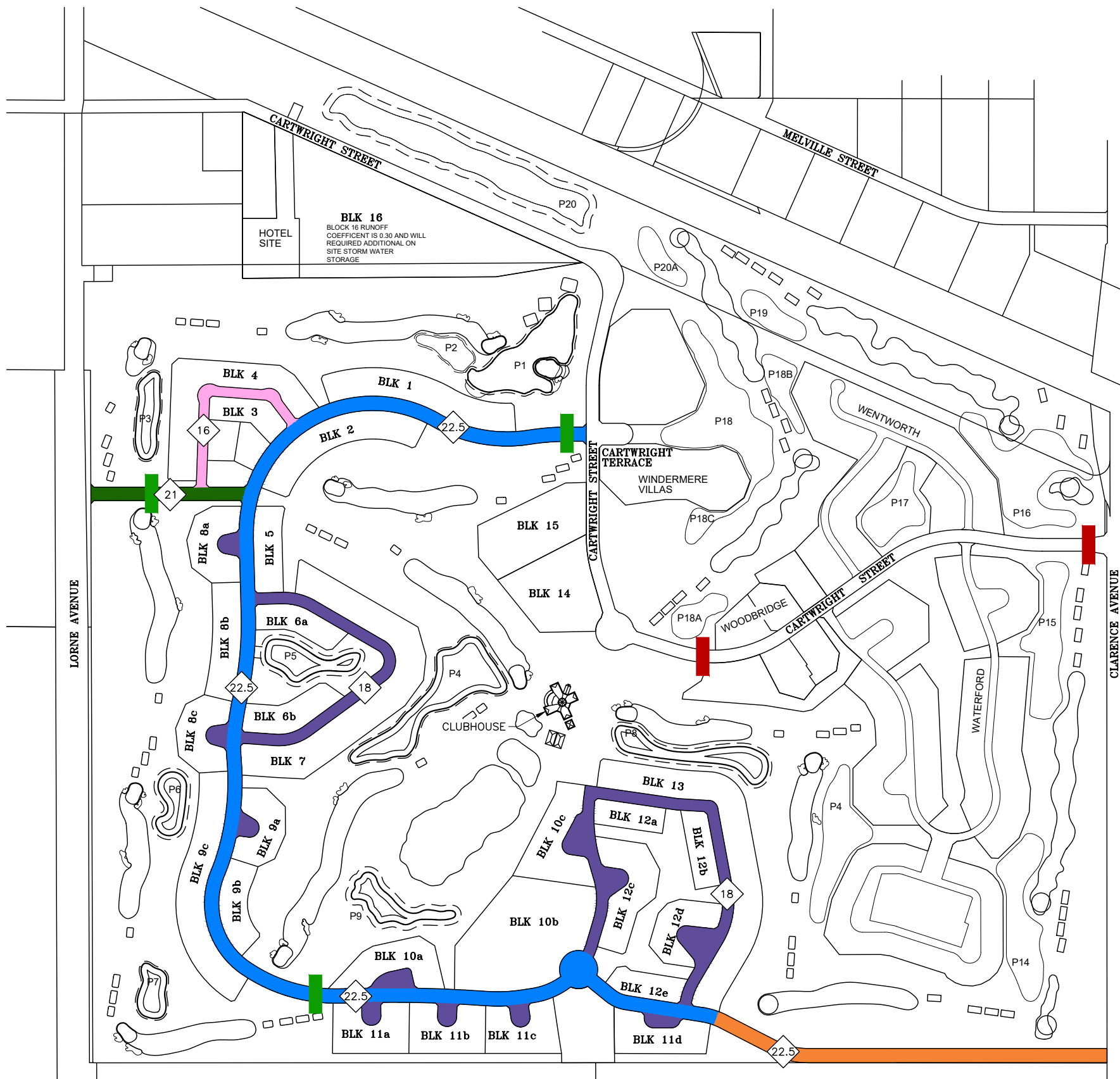
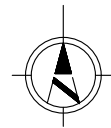

**LEGEND:**

- COLLECTOR RESIDENTIAL A
- COLLECTOR RESIDENTIAL B
- COLLECTOR RESIDENTIAL C
- LOCAL RESIDENTIAL A
- LOCAL RESIDENTIAL B
- RIGHT-OF-WAY WIDTH (m)
- EXISTING CART TUNNEL
- PROPOSED CART TUNNEL

VERTICAL CURB IS PROPOSED ON ALL CROSS SECTIONS UNLESS FRONTING ONE UNIT DWELLINGS.

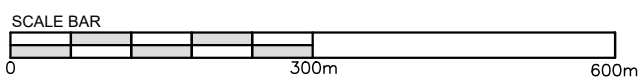

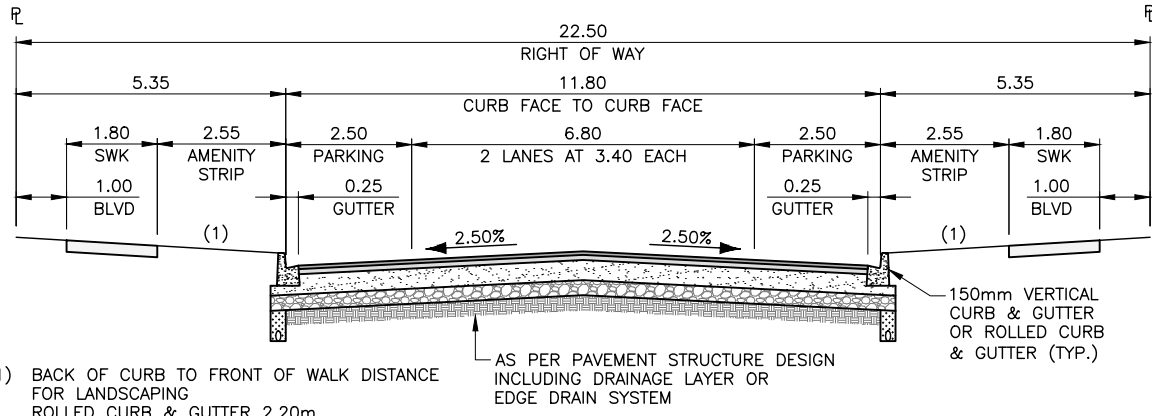

(1) BACK OF CURB TO FRONT OF WALK DISTANCE FOR LANDSCAPING  
 ROLLED CURB & GUTTER 2.20m  
 VERTICAL CURB & GUTTER 2.40m

**COLLECTOR RESIDENTIAL A TYPICAL SECTION**

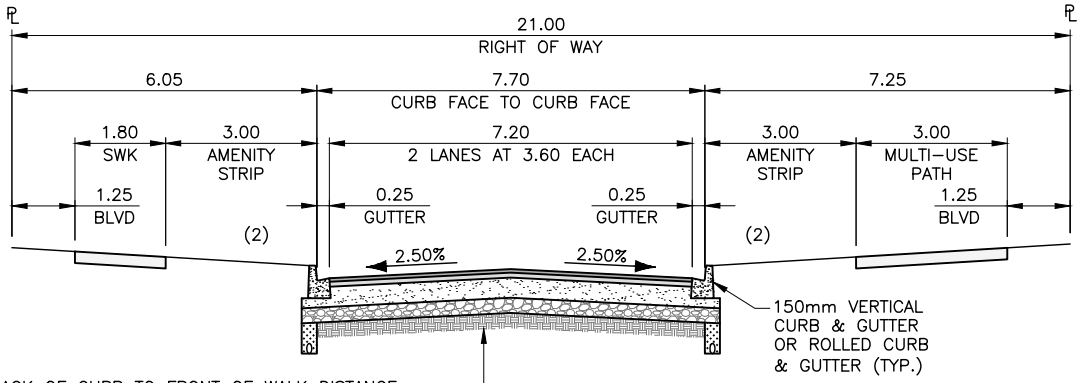

(2) BACK OF CURB TO FRONT OF WALK DISTANCE FOR LANDSCAPING  
 ROLLED CURB & GUTTER 2.65m  
 VERTICAL CURB & GUTTER 2.85m

**COLLECTOR RESIDENTIAL B TYPICAL SECTION**

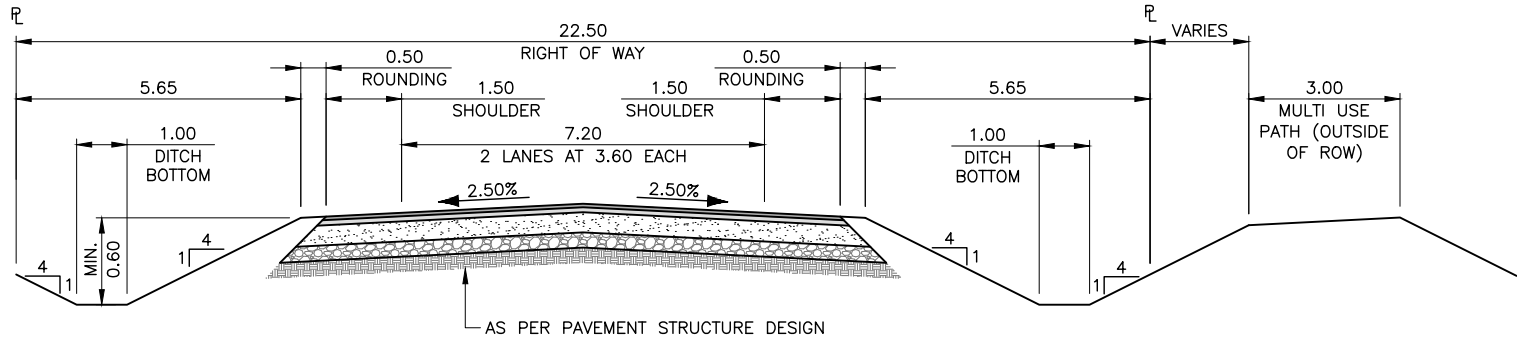

AS PER PAVEMENT STRUCTURE DESIGN

**COLLECTOR RESIDENTIAL C TYPICAL SECTION**

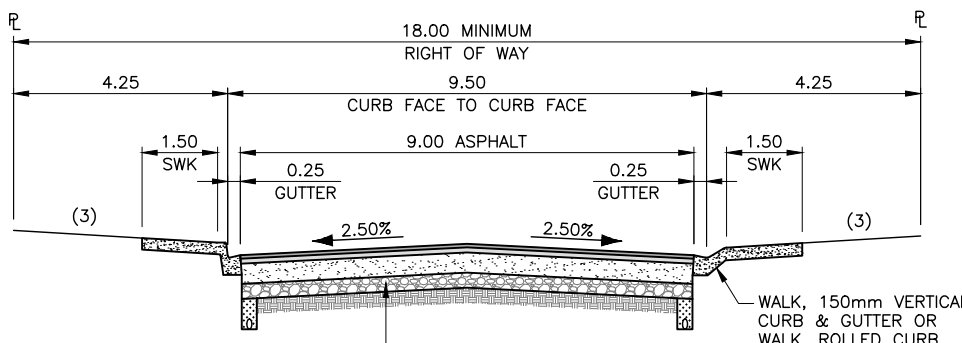

(3) BACK OF WALK TO PROPERTY LINE DISTANCE FOR LANDSCAPING  
 ROLLED CURB & GUTTER 2.35m  
 VERTICAL CURB & GUTTER 2.55m

**LOCAL RESIDENTIAL A TYPICAL SECTION**

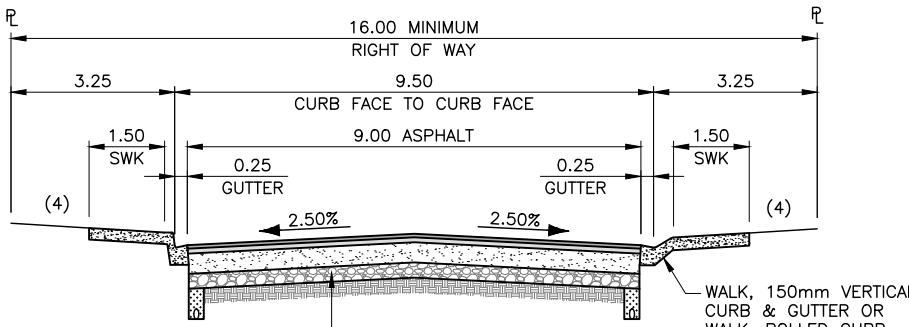

(4) BACK OF WALK TO PROPERTY LINE DISTANCE FOR LANDSCAPING  
 ROLLED CURB & GUTTER 1.35m  
 VERTICAL CURB & GUTTER 1.55m

**LOCAL RESIDENTIAL B TYPICAL SECTION**

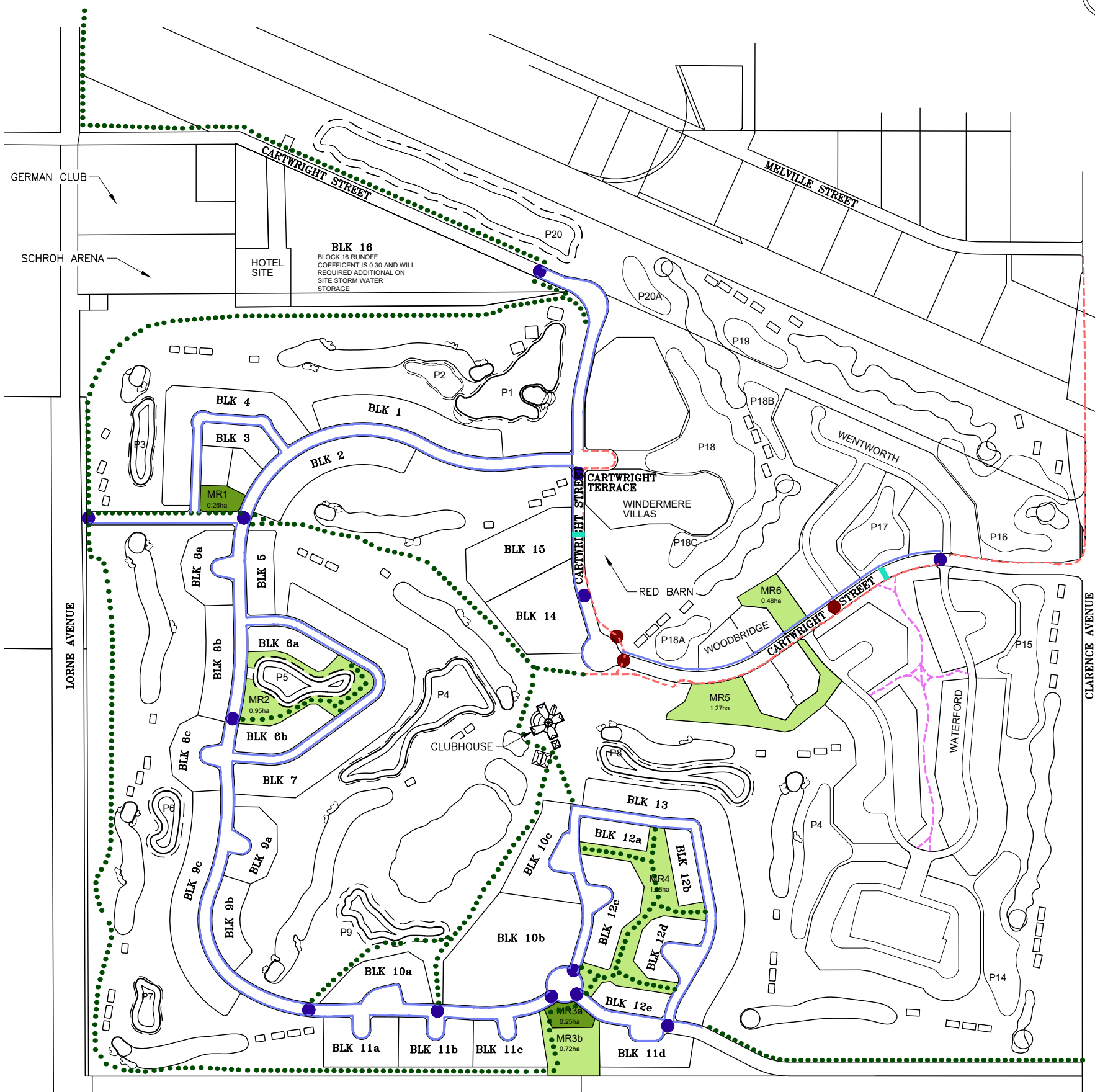
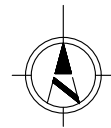

**LEGEND:**

- LINEAR PARK
- POCKET PARK
- EXISTING DESIGNATED CROSSWALK
- PROPOSED DESIGNATED CROSSWALK
- PROPOSED SPEED CUSHION
- EXISTING SIDEWALK
- EXISTING PATHWAY
- PROPOSED SIDEWALK
- PROPOSED PATHWAY

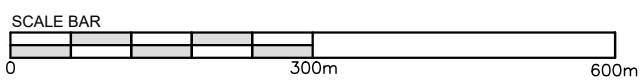

## 6.0 SERVICING

### 6.1 STORMWATER

Figure 6.0 Stormwater Ponds and Catchments illustrates the layout of the stormwater ponds and catchment areas aimed to service the proposed CPA area. The proposed storm servicing concept was modelled using XPSWMM by XP software, as required in the current City of Saskatoon Design and Development Standards Manual (DDSM). Figure 7.0 displays a stormwater connectivity schematic for the Willows CPA area. Figures 7.1 and 7.2 display the major storm sewer layout and overland flow routes, respectively.

The Willows XPSWMM storm model used for this review includes:

- The proposed Willows expansion in the west half of the subdivision
- The existing Willows development in the east half of the subdivision
- The Cartwright Pond (storage node P20), located between Cartwright Street and CN Rail
- A residential area tributary to the Stonebridge storm trunk, upstream of the Cartwright Pond

Both the existing and proposed Willows storm systems converge on the Cartwright Pond, which was re-designed in 2012 as part of the Circle Drive South Project. The upgraded pond has a bottom elevation of 494.30 m, a normal water level (NWL) of 497.40 m, a top of berm elevation 502.50 m (according to City of Saskatoon records), and a maximum design outflow of 2.85 m<sup>3</sup>/s.

Pre and post-development pond storage was simulated with the City of Saskatoon's 1:100 year 24 hour design storm (historical storm of June 24, 1983). The minor system was also reviewed with the City of Saskatoon's 1:2 year, 1 hour design storm.

The model includes the updated set of XPSWMM infiltration parameters published in the current version of the City's DDSM (Section 6, Table B-5). It is important to note that the infiltration parameters used in this analysis may vary from the parameters used in the design of the existing Willows development in 2001, as well as those used to re-design the Cartwright Pond in 2012.

The proposed Willows development was divided into 51 preliminary storm drainage areas, all serviced by 9 cascading storm ponds, of which some are existing and some are proposed. All ponds except pond P20 would be maintained by the private golf course Owner (Willows Golf Inc.). A freeboard of 1.0m will be provided from ponds' high water level (HWL) to property lines. All pond floor, normal water level, high water level, and freeboard elevations will be confirmed during the detailed design stage. The majority of the ponds will be inter-connected by storm sewer piping except P2 and P1 which will be connected via a concrete channel. Some sections of the storm sewers may be permanently submerged. Freezing mitigations measures will be considered during the detailed design stage. All ponds, pond inlets, and outlets will be designed accordance with the City of Saskatoon Design & Development Standards.

A pre and post-development comparison of the proposed Willows expansion increases the overall imperviousness by 12%. Post-development land-uses are as shown in the CPA (refer to Figure 3.0 Concept Plan). This is a mix of proposed residential development,

existing and proposed storm ponds as well as open space land. The overall imperviousness for the post-development is 27%. The pre-development land uses include the golf course features and the club house with an overall imperviousness of 15%.

The post-development active storage volumes required for the historical design storm are summarized in Table 6-1.

**Table 6-1 Ponds Active Storage and Depth**

Pond	Active storage depth required for historical design storm (m)	Active storage required for historical design storm (m <sup>3</sup> )
1	0.91	11,400
2	0.15	400
3	0.40	1,900
4	1.00	16,200
5	1.03	6,700
6	0.86	3,800
7	0.41	1,400
8	0.78	6,500
9	1.29	8,200
Total active storage volumes (m <sup>3</sup> )		56,500

The impact of the proposed Willows expansion on the downstream storm system was also evaluated for the historical design storm. The pre and post-development HWL elevations and discharge rates of the Cartwright Pond are summarized in Table 6-2.

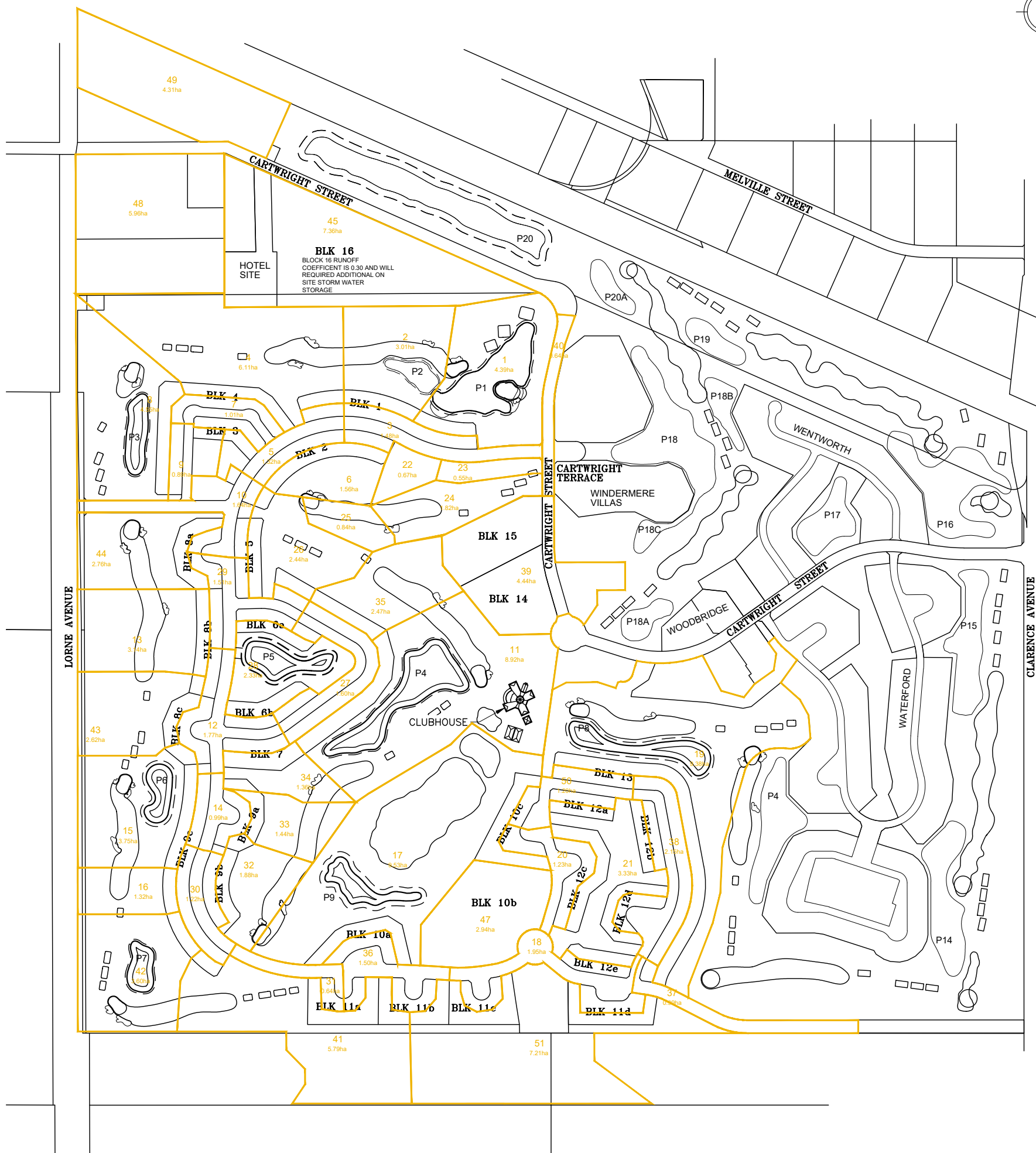
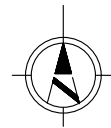

**LEGEND:**

— PROPOSED STORM CATCHMENT AREA

15 3.75ha CATCHMENT AREA DESCRIPTOR

P5 STORM WATER POND  
 — NWL  
 — HWL

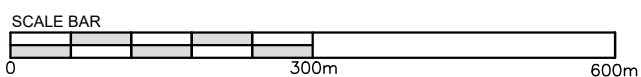

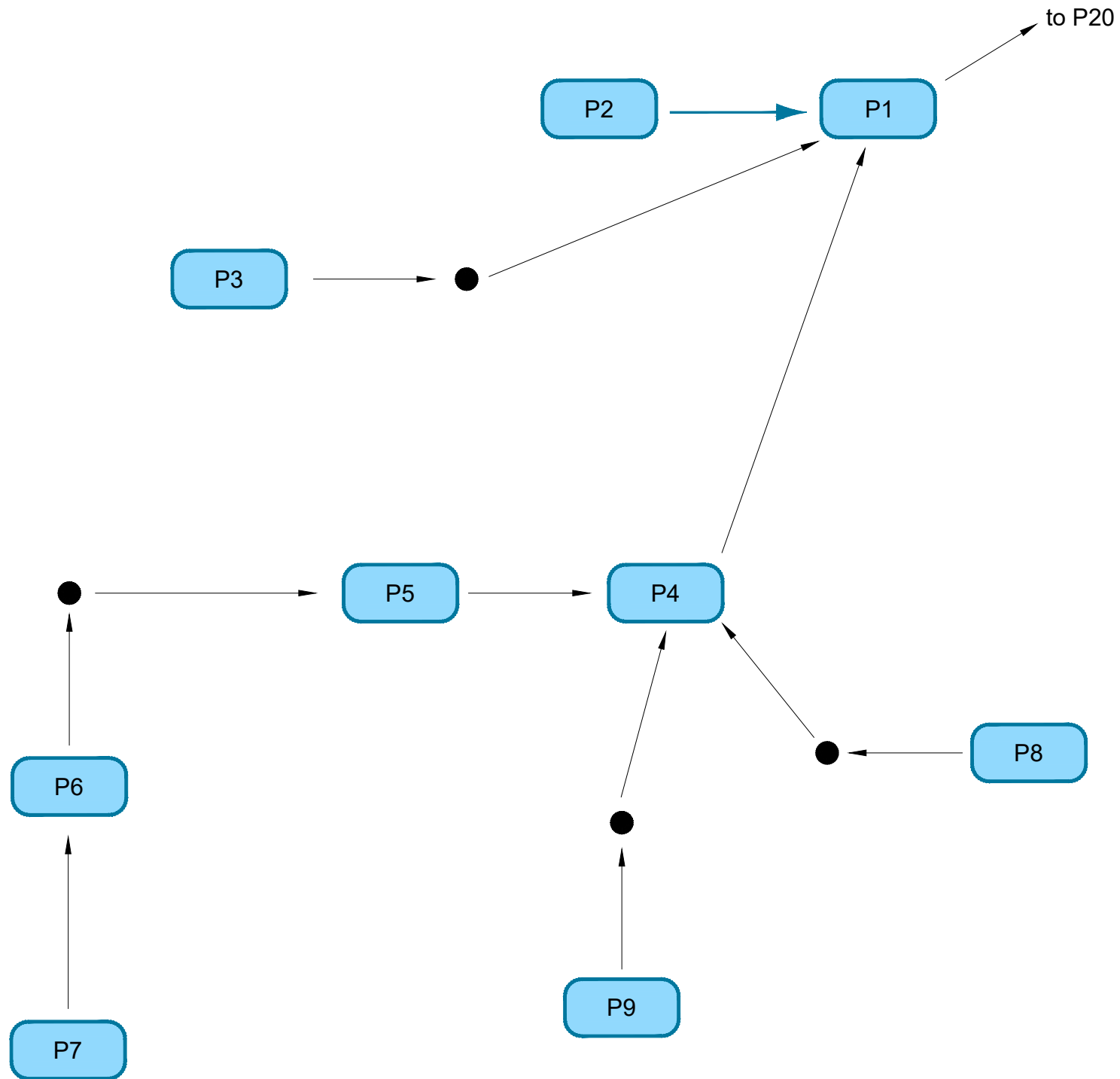

**LEGEND:**

- P6 STORM POND
- PIPED CONNECTION
- CONCRETE CHANNEL

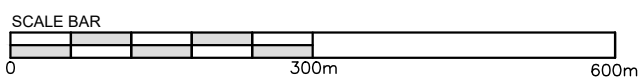

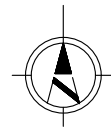

**LEGEND:**

- |  |                             |  |                            |
|--|-----------------------------|--|----------------------------|
|  | EXISTING 300mm STORM SEWER  |  | PROPOSED 300mm STORM SEWER |
|  | EXISTING 375mm STORM SEWER  |  | PROPOSED 450mm STORM SEWER |
|  | EXISTING 450mm STORM SEWER  |  | PROPOSED 525mm STORM SEWER |
|  | EXISTING 600mm STORM SEWER  |  | PROPOSED 600mm STORM SEWER |
|  | EXISTING 750mm STORM SEWER  |  | PROPOSED 750mm STORM SEWER |
|  | EXISTING 900mm STORM SEWER  |  | PROPOSED 900mm STORM SEWER |
|  | EXISTING 1350mm STORM SEWER |  | FUTURE 600mm STORM SEWER   |
|  | MANHOLE                     |  |                            |
|  | DESIGN ROAD C ELEVATION     |  |                            |

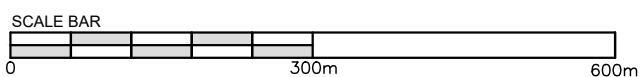



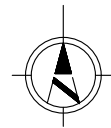

**LEGEND:**

OVERLAND FLOW DIRECTION

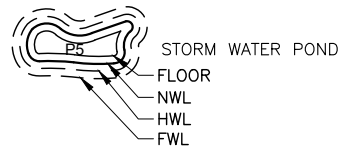

POND ELEVATIONS				
POND	FLOOR	NWL	HWL	FWL
1	498.00	500.50	501.41	502.41
2	500.60	502.10	502.25	503.25
3	500.50	503.00	503.40	504.40
4	499.60	502.10	503.10	504.10
5	499.70	502.20	503.23	504.23
6	500.20	502.70	503.56	504.56
7	500.85	503.35	503.76	504.76
8	500.00	502.50	503.28	504.28
9	500.50	503.00	504.29	505.29

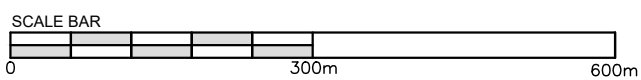

**Table 6-2 Cartwright Pond Results Summary for Historical Design Storm**

	Pre-Development Land Use	Post-Development Land Use
HWL (m)	499.43	499.68
Max. Discharge (m <sup>3</sup> /s)	2.87	2.95
Net increase in discharge (%)		2.8%
Net increase in Active Storage Depth (%)		12.3%

As noted above, the post-development flow from the Willows is an increase from the pre-development assumptions. The City of Saskatoon provide updated modelling data from their south end storm sewer model to include in this review. The maximum discharge was found to be 2.95 m<sup>3</sup>/s, resulting in a 2.8% increase from the pre-development peak discharge rate. The model was constructed utilizing the City of Saskatoon’s existing downstream conditions, which included the storm water systems for the Stonebridge & CN Industrial neighborhoods, as well as the Circle Drive outfall into the river. The HWL was found to be 499.68 resulting in a 12.3% increase of active storage depth (NWL to HWL) compared to the pre-development HWL. The post-development HWL resides below the Cartwright Pond’s top of berm elevation, 502.50. All stormwater modelling, parameters, results will be confirmed during the detailed design stage. It should be noted that the park areas adjacent to the ponds will provide additional storage volumes within any low areas incorporated into their design.

It should be noted that future commercial and industrial development areas, as well as Block 16 have been considered along Cartwright Street near Lorne Avenue as part of the modelling exercise. These parcels will need to connect into the Cartwright Pond for storm water retention. Details of site requirements and allowable runoff coefficients will need to be determined by the City when development is considered; however, modelling indicates that the Cartwright Pond has the ability to collect runoff from these parcels during a major storm event. It should be noted that these parcels have been modelled with a design runoff coefficient of 0.30 (the typical runoff design coefficient for these types of parcels is 0.6). Development of these parcels will require additional onsite stormwater storage requirements.

## 6.2 WATER DISTRIBUTION

### 6.2.1 Water Distribution System Concept

Figure 8.0 Water Distribution Plan shows a piping schematic of the CPA, along with junction naming and connection points. From the existing 300mm main, a 250mm diameter water main loop extends from the 300mm stub at junction J-2 back to the second tie-in location at junction

J-20 to service Phase 2. Two 200 mm diameter loops divert from the main 250 mm loop to service the medium density areas in the northwest and southeast, and a 200mm diameter loop runs through the low-density cul-de-sacs on the west side and in the southeast part of the main loop. As is typical local standard construction practice, PVC piping material was used for all piping, with a 120 Hazen Williams roughness coefficient applied for modeling purposes. The conceptual water model of the water main system for the Willows Phase 2 was completed as per guidelines identified in the City of Saskatoon Design and Development Standards Manual (DDSM).

## 6.2.2 Boundary Conditions

Boundary conditions were provided by the City of Saskatoon from their water model and were applied to the Melville Street and Clarence Avenue tie-in points. Location #1 and Location #4 are the Melville Street and Clarence Avenue tie-in locations for the entire Willows Subdivision, including the first constructed phase. Locations #2 and #3 are the proposed tie-in locations for Phase 2 of the Willows. The boundary condition elevations and pressures provided by the City were to 3 m below grade. All model junctions were corrected to proposed/existing finished grade elevations.

## 6.2.3 Population and Demand

For the CPA, there are five different population density zones planned as displayed in Table 6-3.

**Table 6-3 Population Densities by Land Use**

Land Use	Ppl/ha	LPCD
One Unit Dwellings	32.9	290
Low Density Multi Unit Dwellings	65.1	290
Medium Density Multi Unit Dwellings	196.8	290
Commercial	160	290

Using the values in the table above and based on land use areas for each population density type, the design population for the model was calculated to be approximately 2,156 people for proposed development. Factoring in actual existing population of Phase 1 (869 people), the total combined population is approximately 3,025 people. Additionally, equivalent populations calculated for future commercial and industrial lands totals 1,025 people. The projections for population and associated demand are based on maximum allowable density for each land use (note this is significantly higher than the actual projection in Table 3.3 using anticipated densities). Three demand scenarios were created and were evaluated for maximum day demand (MDD), MDD plus fire flow, and peak hour demand (PHD).

## 6.2.4 Consumptive Demand Scenarios

The City of Saskatoon assumes each person consumes 290 liters of water per day. Each junction was given a consumptive demand based on the adjacent land use, population and demand scenario as seen in Table 6-3 above.

The total calculated consumptive demand by scenarios are as follows:

- ADD is 11.28 L/s;
- MDD is 28.06 L/s; and
- PHD is 40.94 L/s.

The pressure range for distribution piping should be between 275 – 690 kPa during MDD or PHD demand scenarios. The MDD pressures ranged between 452 kPa to 493 kPa, and the PHD pressures ranged between 452 ka and 493 kPa. The modeled MDD and PHD consumptive demand scenarios showed the water network was able to provide a level of pressure service within the City's required pressure range. The maximum pipe velocities should be less than 1.5 m/s (general) or up to 3.0 m/s (maximum localized velocity). The PHD scenario maximum pipe velocity was less than the maximum allowable velocity at 0.33 m/s.

## 6.2.5 Fire Flow Scenario

Fire flow was analyzed in conjunction with MDD consumptive demands. The minimum fire flow requirements are dependent on land use values and densities. Low density residential requires 90 L/s fire flow, medium density requires a minimum of 150 L/s fire flow, and commercial/industrial requires 220 L/s fire flow. A minimum residual pressure of 140 kPa must be maintained under fire flow conditions, and the maximum allowable pipe velocity should not exceed 3.0 m/s. The modeled fire flow scenario indicates that the minimum allowable residual pressure during a fire flow event was met, with the lowest modeled residual pressure at 309 kPa. The highest modeled pipe velocity was found to be 3.0 m/s, falling within City guidelines. Table 6-4 provides a summary of the hydraulic conditions for all demand scenarios.

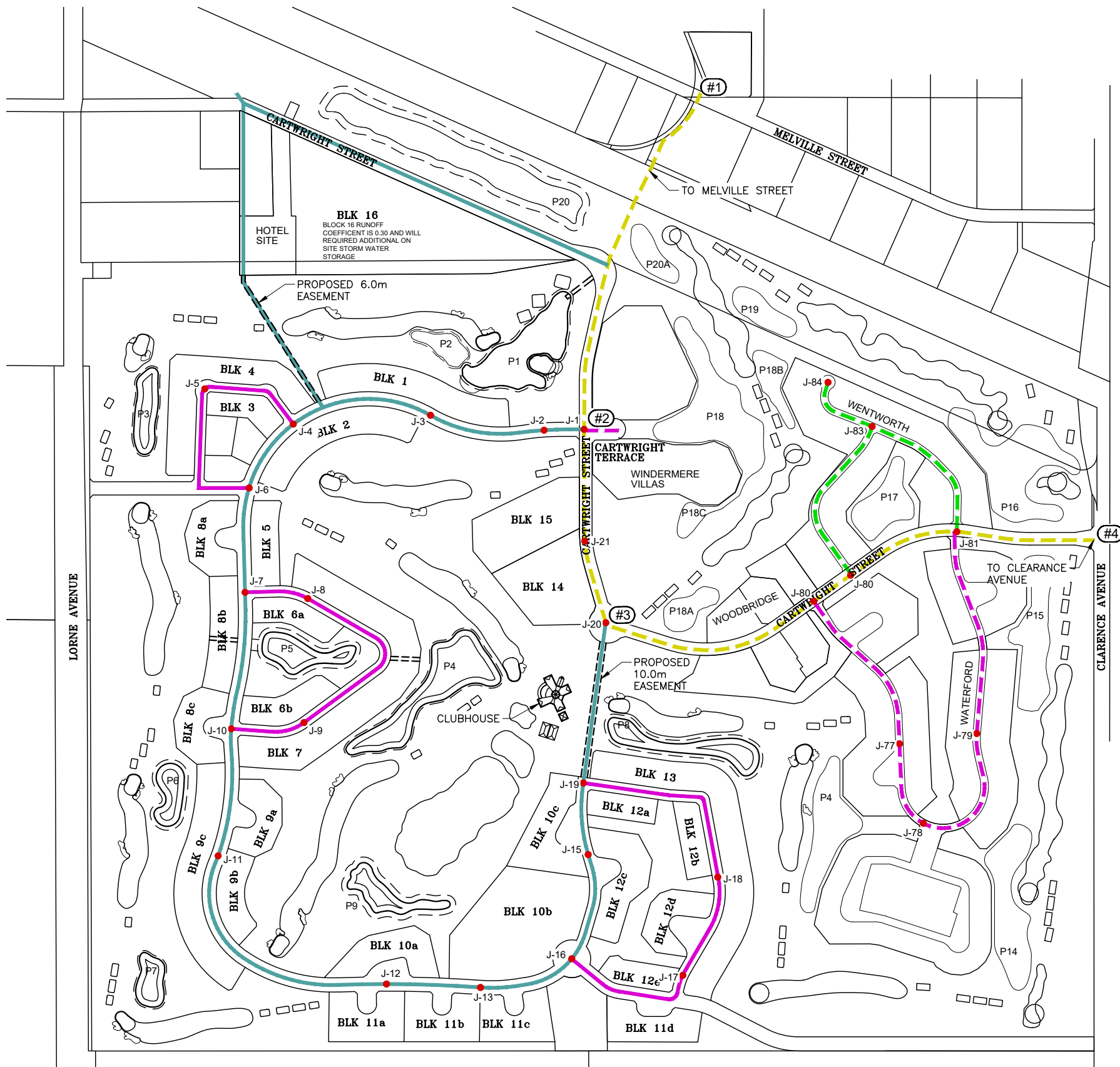
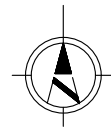

**LEGEND:**

- EXISTING 150mm WATER MAIN
- EXISTING 200mm WATER MAIN
- EXISTING 300mm WATER MAIN
- PROPOSED 200mm WATER MAIN
- PROPOSED 250mm WATER MAIN
- PROPOSED 300mm WATER MAIN
- #1 CONNECTION LOCATION

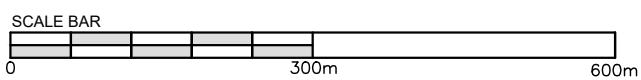

**Table 6-4 Model Analysis Summary of Hydraulic Conditions by Demand Scenario**

Scenario	Minimum Pressure (kPa)	Maximum Pressure (kPa)	City Pressure Allowed (kPa)	Maximum Pipe Velocity (m/s)	Maximum Allowable Pipe Velocity (L/s)	Available Fire Flow (L/s)	Minimum Required Fire Flow (L/s)
MDD	453 @ J-50	505 @ J-51	275 min – 690 max (distribution)	N/A	N/A	N/A	N/A
PHD	450 @ J-50	502 @ J-51	275 min – 690 max (distribution)	0.33 @ P-57	1.5 (general) up to 3.0 (localized max)	N/A	N/A
MDD + Fire Flow	*452 @ J-50	*503 @ J-51	*140 min.	3.0 @ P-29	3.0	All Junctions meet 90 L/s, 150 L/s, and 220 L/s minimum Fire Flow for respective land use.	90 L/s (Low Density Res.); 150 L/s (Medium Density Res.); 220 L/s (Commercial/Industrial)

All of the modeled consumptive demand and fire flow scenarios demonstrated that the City’s required hydraulic conditions could be met with the proposed network design.

Future commercial and industrial development areas have been considered along Cartwright Street near Lorne Avenue. These parcels will be serviced via a 250mm Water Main along Cartwright Street that would be looped through the golf course as shown in Figure 8.0.

## 6.3 SANITARY SEWER

### 6.3.1 Background

Phase 1 of the Willows neighbourhood ties into the City of Saskatoon municipal system at Melville Street. This connection consists of a 250 mm diameter pipe which crosses the CNR tracks. This pipe has been installed at a slope of 0.24% with a full flow capacity of 29.1 L/s. With development of Phase 2, both Phase 1 & 2 flows will be serviced by a new trunk sewer installed up to Cartwright Street from the north, constructed by the City of Saskatoon. Phase 2 of the Willows development will also be serviced by this trunk.

Based on correspondence with the City of Saskatoon, the Melville Street sanitary sewer drains the Willows to the Jasper Avenue lift station which also services Stonebridge, Avalon, and the CN Industrial neighbourhoods. The design capacity of the Jasper Avenue lift station is 284 L/s wet peak flow. The City of Saskatoon had previously allowed for a 35.2 L/s peak sanitary sewer flow for all phases of the Willows development (existing and proposed); however, recent conversations with the City have indicated that a new trunk sewer will be brought to the Willows Development area up to Cartwright Street from the northwest, resulting in additional capacity being available.

A conceptual level layout for the sanitary sewer system has been developed, based primarily on the following information:

- Concept Plan Amendment;
- Correspondence with the City of Saskatoon; and
- City of Saskatoon Design and Development Standards.

### 6.3.2 Conceptual Design

The grading of the proposed development was driven by the existing topography as well as the stormwater management requirements to provide adequate emergency overland drainage. The sanitary sewers were designed in order to maintain a minimum bury depth given the grading design of the site. The sanitary demand for the CPA area was calculated using projections outlined in Table 3-3. The commercial site (Wellness Hotel/Spa) demand was calculated based on the City of Saskatoon design standard of 160 ppl/ha. Table 6-5 below, summarizes the land uses and demand rates used.

**Table 6-5 Land Use Density and Flow for Sanitary Sewers**

Land Use Zoning	Ppl/ha	Average Day Wet Flow (LPCD/L/s/ha)
One Unit Dwellings	32.9	290 LPCD
Low Density Multiple Unit Dwellings	65.1	290 LPCD
Medium Density Multi Unit Dwellings	196.8	290 LPCD
Commercial	160.0	290 LPCD
Inflow/Infiltration		0.17 L/s/ha

The average daily demand per capita for residential land is outlined in the Saskatoon Design and Development Standards Manual. A peaking factor is applied to each demand catchment based on the cumulative population and calculated using the Harmon Peaking Factor Formula. An inflow and infiltration rate of 0.17L/s/ha as per discussions with City of Saskatoon and the flow monitoring report (Appendix B).

Future commercial and residential development areas have been considered along Cartwright Street near Lorne Avenue. These parcels will be serviced via a proposed 300mm local sanitary sewer main which will tie into the proposed 375mm Sanitary Sewer Trunk installed up to Cartwright Street from the north, constructed by the City of Saskatoon. Conceptual routing is shown in Figure No. 9.0.

### 6.3.3 Flow Calculation Results

The analysis, based on the City of Saskatoon Design and Development Standards and information provided by Dream, represents a total of approximately 2,156 additional people in Phase 2, including the commercial site, and 869 estimated residents in the existing Phase 1. The 869 estimated population of Phase 1 of the Willows is in alignment with the City of Saskatoon Neighbourhood Profile data plus estimated populations from units under development at 404 and 408 Cartwright. The results of the conceptual design for the sanitary sewer system indicate a wastewater peak flow of 30.3 L/s for Phase 2 residential and 2.4 L/s for the proposed commercial site. Wastewater peak flow for existing Phase 1 is estimated at 14.6 L/s, and the clubhouse is measured at 0.1 L/s, for a total estimated flow of 60.5 L/s. This includes future light industrial and commercials at the corner of Lorne Avenue and Cartwright Street of 1.5 L/s and 11.7 L/s respectively.

### 6.3.4 Flow Monitoring

A flow monitoring study was undertaken on the existing Willows sanitary sewer system with flow monitors installed in three locations. Locations of the flow monitors and results can be found in the report in Appendix B.

The Willows is a unique subdivision due to its demographic. The subdivision consists of many retired residents and less families than the typical Saskatoon neighbourhood. This results in a decreased demand for services. There are also seasonal residents in the subdivision that will not be using the services year round and will decrease demand for services. Flow monitors were installed to confirm if this was the case.

The data obtained by the three flow monitors indicates that the existing Willows neighborhood is contributing less flow than anticipated. Peak flow from the flow monitoring results is calculated at 8.17L/s based on average daily sanitary flow (ADSF) of 2.18 L/s. Most notably for the purpose of design, the clubhouse average dry weather flow (ADF) was 0.03L/s. After applying a peak flow rate of 3.33, a design peak flow rate of 0.1 L/s was used.

### 6.3.5 Sanitary Connections

The sanitary sewer main serving each of the sub-phases has been sized as a 250mm diameter main. Layout of the proposed sanitary system and select inverts are shown in Figure 9.0 Sanitary Sewer. The actual invert of the sanitary sewer main connections may vary based on the final grading designs of the site.

As the proposed peak wastewater flow is greater than the available capacity (29.1 L/s) of the existing sanitary sewer crossing at the CNR railway, it is proposed that a new 375mm trunk sewer be ran up to Cartwright Street from the northwest, constructed by the City of



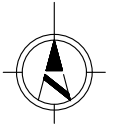

**LEGEND:**

- EXISTING 200mm SANITARY SEWER
- EXISTING 250mm SANITARY SEWER
- PROPOSED 200mm SANITARY SEWER
- PROPOSED 250mm SANITARY SEWER
- PROPOSED 300mm SANITARY SEWER
- PROPOSED 375mm SANITARY SEWER
- - - FUTURE 200mm SANITARY SEWER (WITH EASEMENT)
- MANHOLE

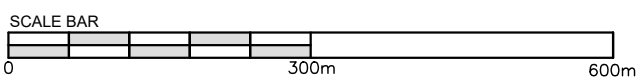

Saskatoon. This trunk will serve both phase 1 & 2. This trunk has also been preliminarily sized to accommodate future light industrial and commercial lands at the corner of Cartwright Street and Lorne Avenue. The existing sanitary sewer crossing at the CNR railway will remain and act as an overflow sewer.

## 6.4 GEOTECHNICAL

### 6.4.1 Ground Water

The Willows Hydrogeological Investigation was completed in 2017 which accessed the hydrogeological conditions of Phase 2 and provided recommendations to mitigate potential risks to residential foundations. Details of the analysis and results can be found within the Hydrogeological Investigation, attached in Appendix H.

The Hydrogeological Investigation has identified that the groundwater flow is towards the north/northeast directions and resides on average about 1.30m below existing ground elevation. It notes that the high groundwater table is attributed to the intensive lawn irrigation and various ponds. Shallower groundwater depths (less than 1.50m below existing ground elevation) were observed in the northeast, east, and south portions of Phase 2. Deeper ground water depths (greater than 2.00m below existing ground elevation) were observed in the northwest corner of Phase 2. The majority of the upper most ground water flow is through the sand and silts of the Furdale Allomember, a subdivision of the Haultain Alloformation. The average hydraulic conductivity of the sand and silt was determined to be  $10^{-5}$ m/s.

Based on the findings of the Investigation, residential basements constructed within the Willows Phase 2 may require mitigation measures. One of the main mitigation measures proposed for Phase 2 of the Willows includes an infiltration system consisting of perforated pipes running adjacent to the proposed storm sewers within the public roadways. The proposed infiltration system and proposed basements are expected to reside within the sand and silt layers as discovered in the Hydrogeological Investigation. The proposed infiltration system will help reduce the groundwater table by draining groundwater into the Willow's storm water management system. Development itself is also expected to reduce the groundwater table as weeping tiles will surround foundations lowering the water table and the reduction of golf course irrigated lands will reduce infiltration. Groundwater mitigation measures will be confirmed during detailed design.

### 6.4.2 Area Grading

Area grading for Phase 2 of the Willows will include re-grading portions of the existing Willows golf course and associated ponds. Area grading will be completed in accordance with the current City of Saskatoon's Design and Development Standards. Existing ponds requiring significant re-grading to allow for development will be drained, excavated (to competent material), and recompacted with suitable backfill material. The proposed area grading plans will be provided at the detailed design stage.

## 7.0 PUBLIC CONSULTATION

### 7.1 SUMMARY OF CONSULTATION

In February 2022, Dream retained Martin Charlton Communications (MCC) to assist with a significant consultation/engagement program with the goal of gaining feedback to revise the Willows CPA in a way that reflects input and support from the Willows residents.

Consultation included the following:

- An online survey routed through each condominium board (May- June 2022).
- 14 meetings with residents, both in-person and virtually (June – July 2022).
- 50 + one-on-one meetings / phone calls between Dream and residents who requested to speak with Dream (May – November 2022).
- Two open houses displaying revisions made from the survey and meetings, seeking further feedback (November 2022).

MCC's report, title "Willows Public Consultations 2022", can be found in Appendix F.

### 7.2 KEY REVISIONS FROM CONSULTATION

The consultation activities outlined in Section 7.1 and from MCC's report in Appendix F produced many suggestions for changes to the Willows CPA. The changes can be summarized as follows. Please note further details can be found in Appendix F.

- Revised Spa / Hotel Location to North Development Area.
- Removal of Commercial/Retail from Concept Plan.
- Replace former Spa / Hotel Site with low density multi-unit dwellings.
- Removal of medium density multi-unit dwelling group in Red Barn area and replace with amenity area / Red Barn improvements.
- Inclusion of additional sidewalks and crosswalks on Cartwright Street that increases pedestrian connectivity.
- A new south residential access (Access D) to Clarence Avenue.
- All directional Access A to Lorne Avenue.
- Removal of residential collector roadway in Phase 2 to existing traffic circle and Cartwright.

## 7.3 FEE SIMPLE OWNERSHIP

A feature of the Willows CPA is to facilitate fee simple ownership, and this item garnered significant attention during the 2021 Council consideration. At that time, many Willows residents expressed concern regarding this type of property ownership versus the existing property ownership type of Bareland Condominium (for One-Unit Dwellings). As a result, Dream retained Brunsdon Lawrek & Associates to complete a Market Analysis of the Willows CPA. The Market Analysis discussed factors that affect market value and whether the Willows CPA will have a negative or positive affect on the values of existing properties. The Market Analysis indicated that there is no evidence to suggest a decline in market values of the entire Willows neighbourhood due to the changes in the 2023 proposed Willows CPA. This report can be found in Appendix G.

Key findings from the Market Analysis include the following:

- The addition of greenspace/parks contributes positively to the neighborhood.
- There is no measured difference in value between a bare land condominium lot and a fee simple lot.
- Successful neighborhoods that maintain their values over time offer a diverse mix of land uses, housing types, and ownership types. The diverse offering allows for a community to adapt to changing market trends over time which help to sustain communities and market values.
- To maintain values, there must be a healthy balance between supply and demand.
- The proposed lots in the concept plan are still larger than the average city lot and will not detract from values in the neighborhood as this is still a unique offering in the city.
- The proposed concept plan will increase the population for the neighbourhood but it is not going to significantly impact traffic to have a negative impact on existing property values.
- Golf courses can have a positive impact on property values provided that the golf course is successful.
- Recent trends in golf course communities are to diversify amenity offerings beyond just offering golf memberships to appeal to a wider and larger market in order to sustain property values.
- There is no measured evidence that the proposed Wellness Hotel/Spa location, the proposed multi-family development, and the proposed fee simple lots would have a negative impact to the existing neighborhood values.

## 8.0 IMPLEMENTATION

### 8.1 DEVELOPMENT PHASING STRATEGY

The development of the CPA has been planned to take place over four sub-phases, 3 to 6 (see Figure 10.0 Sub-Phasing Plan). Sub-phase 3 will connect Cartwright Street to Lorne Avenue and will contain one-unit dwellings, low density multi-family dwellings, as well as the potential to develop the North Development Area. Sub-phases 4 and 5 will continue development south and east of sub-phase 3 and will contain one-unit dwellings and low density multi-family dwellings. Sub-phase 4 will also include the connection to Clarence Avenue. Primarily one unit dwelling sub-phases will be developed sequentially to coincide with golf course operations and reconstruction. Stand-alone multi-family parcels and the commercial parcel (Wellness Hotel/Spa) can be developed independent of this and would be based on market demand. The Sub-Phasing Plan is subject to change once detailed design begins and discussions occur with the City on the extension of services. A phasing strategy will be discussed with the City as to what lands can be developed prior to completion of the future sewer Trunk Main such that development can proceed prior to completion of the trunk.

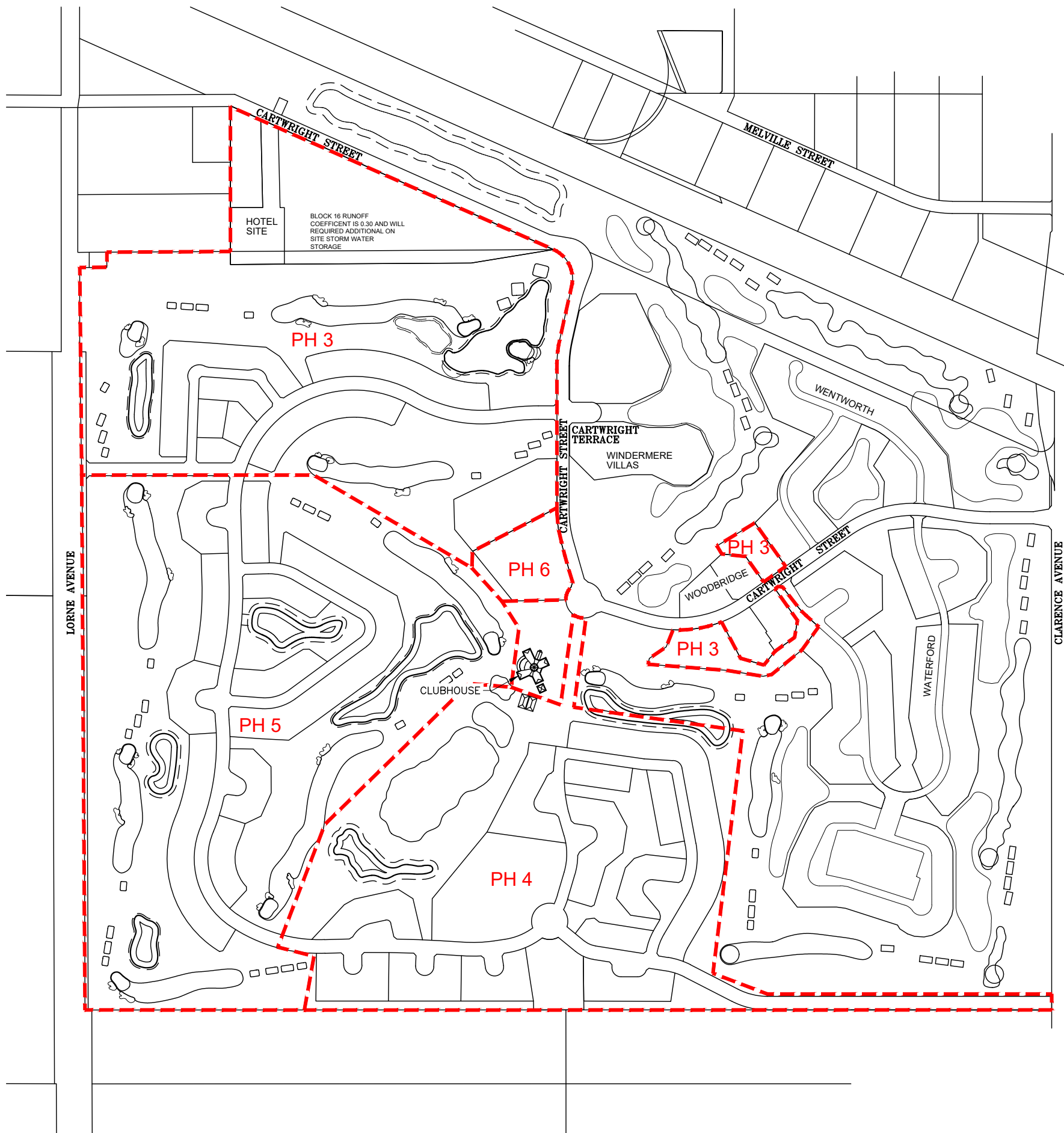
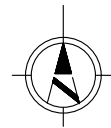

**LEGEND:**

- - - - - PHASE BOUNDARY
- PH XX SUB-PHASE NAME

